

A black and white photograph of architectural blueprints spread out on a table. A pen and a ruler are visible in the foreground, resting on the blueprints. The blueprints show various technical drawings, including floor plans and elevations, with handwritten notes and dimensions. The scene is lit from the side, creating strong shadows and highlights.

**Zoning Ordinance
Technical Manual
for
Single-Family
Residential Zones**

12/13/06

For all
your
permit
needs,
come to
the

City Development Center



across
the
street
from
City Hall

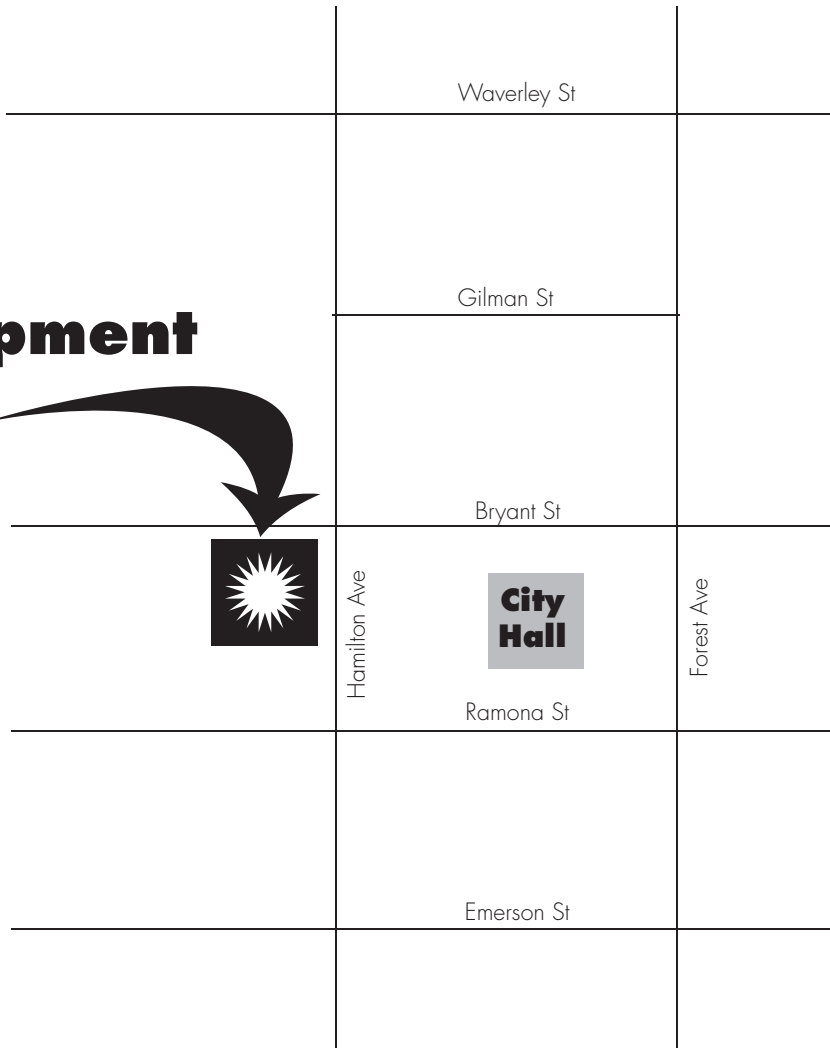

City of Palo Alto Development Center

285 Hamilton Avenue
Palo Alto, CA 94301

[http://www.cityofpaloalto.org/
planning-community/dev-index.html](http://www.cityofpaloalto.org/planning-community/dev-index.html)

Phone: (650) 617-3118

Hours:

Monday, Tuesday, Thursday, & Friday

from **8:00 am** to **12:00 noon**

closed for lunch

and from **1:00 pm** to **4:00 pm.**

Wednesday

from **9:00 am** to **12:00 noon**

closed for lunch

and from **1:00 pm** to **4:00 pm**

zoning
ordinance
technical
manual



**single-family
residential
zones**

Contents

Introduction	1
---------------------------	---

Lot size

Min. & max. lot sizes	
Min. & max. lot sizes by zone	2
Exceptions to the max. lot size	2
Substandard lots	
Substandard lot sizes by zone	2
Special regulations for substandard lots	2
Gross vs net lot area	
Areas excluded from the net lot size	3

Lot coverage & Floor area

Lot coverage	
Maximum allowable	4
Lot coverage includes	4
Lot coverage excludes	4
Gross floor area	
Maximum allowable	4
Gross floor area includes	4
What counts as floor area summary	5

Porches & entry features

Porch types	6
Roofed porches on the 1st floor	8
Vaulted entry features	11
Recessed porches on the 1st floor	14
Balconies, decks, porches, etc on upper floors	15

Attic spaces & equivalencies

Attics, closets, & perimeter spaces	16
2nd & 3rd floor equivalency	17

Projections

Bay window projections	18
Fireplaces, chimneys, sheds, planters, etc.	19

Setbacks

Standard setbacks	
Standard setbacks by zone	20
Special setbacks	
Streets w/special setbacks	20
Contextual front setbacks	
How to determine if a contextual setback applies	21
Setback considerations	
Easements	22
Sidewalks	22
Oddly shaped lots	22
Flags and substandard lots	22
Determining setbacks on oddly shaped lots	23
Allowable setback encroachments summary	24
Allowable rear encroachment	24
Allowable extensions to existing encroachments	25

Daylight plane

Primary daylight plane (side) 26
Primary daylight plane (rear) 28
Allowable daylight plane protrusions summary 29

Accessory structures (non-dwelling)

Accessory structure standards 30
Accessory structure site planning 31
Accessory structure daylight plane (sides & rear) 32
Noise-producing equipment site planning 33

Parking

Parking space standards 34
Carport standards 35
Driveway standards 36
Contextual garage placement
 How to determine if contextual garage placement applies 37
Attached garages/carports site planning 38
Detached garage/carports site planning 39

Basements & excavated features

Basements 40
Excavated features 40
Excavation considerations
 Tree protection 41
 Architectural compatibility and landscape screening 41
Light well & stairwell standards & site planning 42
Below-grade patio standards & site planning 43

2nd dwelling units

2nd dwelling units standards & site planning
 Attached units 44
 Detached units 44
 Min. lot size for 2nd dwelling units by zone 44
2nd dwelling units & associated parking site planning 45

Height & Grade

Height 46
Grade 47

Introduction

The Zoning Ordinance Technical Manual includes illustrations, terms, definitions, and other technical information to provide for the consistent application of the zoning ordinance. The technical manual also includes supporting documents to indicate the underlying intent and basis for many of the zoning ordinance provisions.

The technical manual is not a comprehensive representation of, nor a substitute for, any chapter in the Municipal Code. It is meant to be a helpful supplement and to be used in conjunction with the Municipal Code.

In the event of any perceived conflict between the technical manual and the Municipal Code, the provisions of the Municipal Code shall prevail.

Lot size

The characteristics of a lot determine its development potential and chief among these characteristics is the area of the lot.

For example, to assure continuity in the appearance of the streetscape throughout our neighborhoods and city, the allowable building size is based on a percentage of the lot area.

Code sections

Page 2
18.12.040 (a) Table 2
18.12.040 (d)
18.12.040 (c)

Page 3
18.04.030 (a) (85)

Minimum & maximum lot sizes

As Palo Alto developed and grew through annexation, each subdivision evolved with unique characteristics e.g., the size of the lots within the subdivision. Five R-1 zones reflect and preserve traditional lotting patterns with criteria for minimum and maximum lot sizes.

Min. & max. lot sizes by zone

The subdivision ordinance requires a new lot to have

- A) width \geq 60' AND depth \geq 100' AND
- B) lot area (in sf) per the following:

Zone District	Minimum	Maximum
R-1	6,000	9,999
R-1(7000)	7,000	13,999
R-1(8000)	8,000	15,999
R-1(10000)	10,000	19,999
R-1(20000)	20,000	39,999

Exceptions to the max. lot size

- Where underlying lot lines must be removed to eliminate non-conformities and results in no net loss of housing.
- Where an adjacent substandard lot of less than 25' in width is combined with another lot and results in no net loss of housing.
- Where the resultant number of lots increases or stays the same and results in no net loss of housing.

Substandard lots

Even within each R-1 zone there are a variety of lot sizes. Smaller lots that meet the following criteria are considered to be substandard.

Substandard lot sizes by zone

A substandard lot is one with

- A) width < 50' OR depth < 83' AND
- B) area \leq the following (83% of min. lot size):

Zone District	Typical lot	Flag lot
R-1	4,980	5,976
R-1(7000)	5,810	6,972
R-1(8000)	6,640	7,968
R-1(10000)	8,300	9,960
R-1(20000)	16,600	19,920

Special regulations for substandard lots

- Maximum building height is single-story and 17' instead of 30'
- For lots less than 50' wide, the required street-side yard is 10' instead of 16'. (*Fig 15 C on p. 23*)
- For lots less than 95' deep, the requirements for locating a garage in the rear or side yards are that it be in the rear half of the lot instead of 75' back from the front lot line.

Note: Determining where lot lines are on the ground may require a boundary survey.

Gross vs. net lot area

Gross lot area is the size of the lot—from lot line to lot line. Development potential is based on the net lot area and while gross and net lot area are the same for most lots in Palo Alto, there are some lots for which portions must be excluded from the gross lot area to establish the net lot area.

Areas excluded from the gross lot size are:

- Street right-of-way (*Area A of Fig 1 on this page*)
- “Pole” portion of a flag lot (*Area B of Fig 2 on this page*)
- Creek channel (*Area C of Fig 3 on this page*)

Fig 1 Gross lot area exclusions: street easements

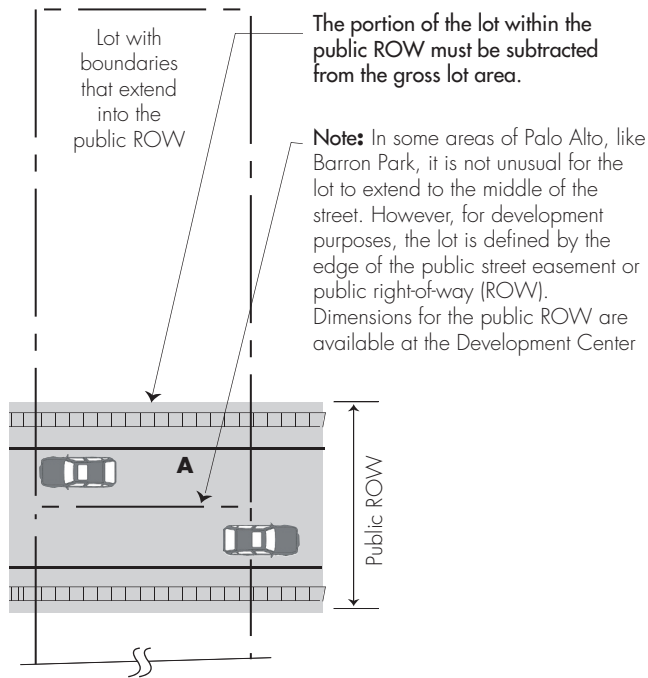

Fig 2 Gross lot area exclusions: flag-lot “poles”

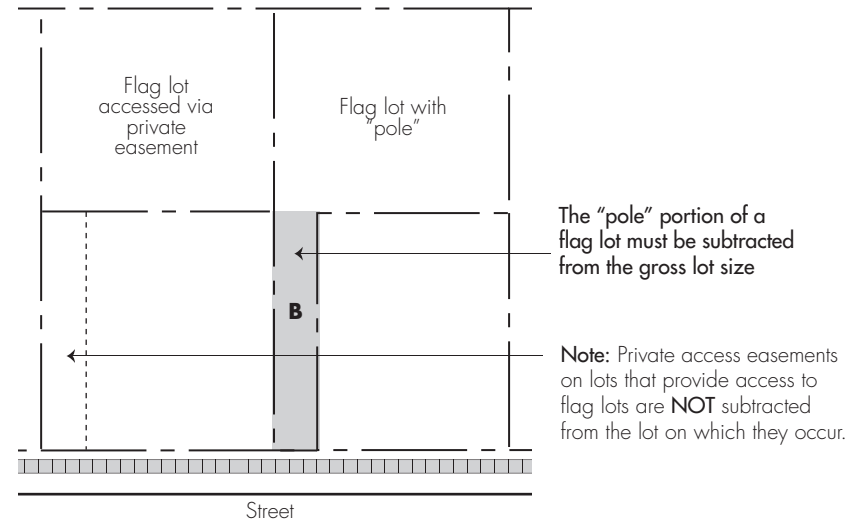
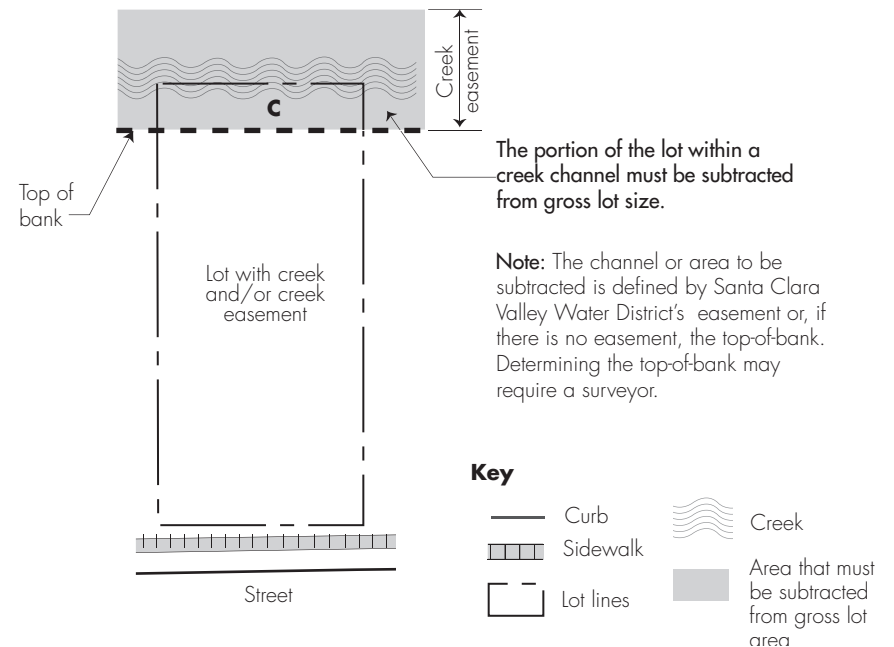

Fig 3 Gross lot area exclusions : creek easements



Lot coverage & floor area

These terms are used to describe the amount of development on a lot.

Lot coverage describes how much of the lot is covered by structures but doesn't evaluate the mass of those structures.

Gross floor area describes the mass of the structures by reflecting the cumulative square footage of all visible levels.

Code sections

Page 4–5

18.12.040 (a) Table 2
18.12.040 (b) Table 3
18.04.030 (a) (86)

Lot coverage

Maximum allowable

Allowable lot coverage is expressed by a ratio—35% of the lot size.

Example calculation:

For a 7,000 sf lot, the allowable lot coverage would be:

$$0.35 \times 7,000 \text{ sf} = 2,450 \text{ sf}$$

Lot coverage includes:

- footprints of all structures including main residence, covered parking, tool sheds, covered pool equipment units, etc.
- projecting elements such as balconies, stairways, porches, patio covers, etc.
- decking that exceeds 30" above grade.
- for roof overhangs or eaves that exceed 4', the portion that is beyond 4'.
- swimming pools and spas that exceed 30" above grade.

Lot coverage excludes:

- roof overhangs up to 4'.
- uncovered structures less than 30" above grade.

An additional 5% coverage is permitted for covered patios, canopies and roof overhangs beyond 4 feet.

Note: To qualify as a structure that is less than 30 inches above grade, a porch or deck may only have open railings above 30 inches—no solid half walls.

Gross Floor area

Maximum allowable

Allowable gross floor area is expressed by a ratio—the sum of 45% of the first 5,000 sf of lot area plus 30% of any portion of lot area in excess of 5,000 sf.

Example calculation:

For a 7,000 sf lot, the allowable gross floor area would be:

$$0.45 \times 5,000 \text{ sf} = 2,250 \text{ sf}$$

$$0.30 \times 2,000 \text{ sf} = 600 \text{ sf}$$

$$\text{Total} = 2,850 \text{ sf}$$

Gross floor area includes:

- the sum of all the floors in a main structure measured to the outside of the exterior stud walls.
- stairwells at all floors and all areas that are greater than 50% enclosed and covered.
- covered parking and all accessory buildings which are greater than 120 square feet.
- spaces that meet the criteria for second and third floor equivalents.

Note: The main house may not exceed 6,000 sf, regardless of the size of the lot.

What counts as floor area summary

Architectural feature	Counts?	Illustration
Porches & entry features		
• Unenclosed porches	No	<i>Fig 5 on pp. 8-10</i>
• Enclosed porches	Once	<i>Fig 5 on pp. 8-10</i>
• Entry feature $\leq 12'$ in height	No	<i>Figs 6-8 on pp. 11-13</i>
• Entry feature $> 12'$ in height	Twice (footprint)	<i>Figs 6-8 on pp. 11-13</i>
• 1st floor recessed porches $< 10'$ in depth and open on exterior side	No	<i>Fig 9 on p. 14</i>
• 2nd floor roofed or enclosed porches, arcades, balconies, porticos, breezeways	Once	<i>Fig 10 on p. 15</i>
Attics & equivalencies		
• Attic space where floor to under side of roof rafter distance is $< 5'$	No	<i>Fig 11 on p. 16</i>
• All 2nd floor space (including attics) where head height or distance from top of floor to bottom of rafter is $\geq 5'$	Once	<i>Fig 11 on p. 16</i>
• 2nd floor equivalent: areas where height from top of first floor to top of roof material is $> 17'$	Twice	<i>Fig 12 on p. 17</i>
• 3rd floor equivalent: areas where height from top of first floor to top of roof material is $> 26'$	Three times	<i>Fig 12 on p. 17</i>
○ Exemption: 3rd floor equivalent, where roof pitch is $\geq 4:12$	200 sf exempt	
○ Exemption: Unusable attic space for Category 1 & 2 historic homes	500 sf exempt	
Basements		
• Basements that comply with patio & lightwell requirements of 18.12.070	No	<i>Figs 35, 36, 39, 40 on pp. 39-43</i>
• Basements of Category 1 & 2 historic homes or contributing structures in a historic district (even if $> 3'$)	No	
Other		
• Bay windows (if $\geq 18"$ above interior flr, does not project $> 2'$, and $> 50\%$ windows)	No	<i>Fig 13 on p. 18</i>
• Architectural appendages like fireplace or buttress footprint	Once	<i>Fig 14 on p. 19</i>
Accessory structures		
• Accessory structures > 120 sf	Once	
• Garages and carports	Once	
• Porte cocheres	No	

Porches & entry features

Facades with defined entryways make a streetscape pleasant and friendly as long as they are not out of scale or proportion.

The gross floor area regulations encourage appropriately sized porches and entryways.

Code sections

18.04.030(a)(65)
18.04.030(a)(113.1)
18.04.030(143.5)
18.12.040(b)Table 3

Porch types

For purposes of assessing gross floor area, porches, entryways, and balconies fall into one of these categories:

- 1. Non-roofed porches, entryways, balconies etc.**
 - Non-roofed features generally do not count
- 2. Roofed porches on the 1st floor** (*Fig 4 A & D on p. 7, Fig 5 on p. 8*)
 - Openess of the sides determines whether or not these count regardless of the height.
 - If they do count, they count only once.
- 3. Roofed entry features on the 1st floor that are less than 12' high (from grade)** (*Fig 4 B on p. 7*)
 - These count once regardless of the design including openness.
- 4. Roofed entry features on the 1st floor that are more than 12' high from grade—"vaulted entry feature"** (*Fig 4 C & D on p. 7, Fig 6, 7, & 8 on pp. 11-13*)
 - These count twice regardless of the design including openness.
- 5. Recessed porches on the 1st floor** (*Fig 9 on p. 14*)
 - Height, depth, & openness determine whether or not these count.
 - If they count and are less than 17' high, they count only once.
 - If they count and are more than 17' high, they count twice.
- 6. Roofed balconies/outdoor areas on upper floors** (*Fig 10 on p. 15*)
 - These count once regardless of the design including openness

The following pages address the details of assessing these features with regard to gross floor area.

Difference between a porch & an entry feature:

A feature is considered to be a porch rather than an entry feature if it can clearly accomodate more activities than entering and leaving the house.

Fig 4 Types of porches and entry ways

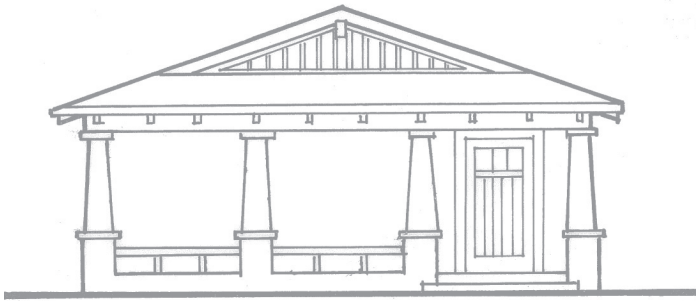

A Roofed porch



C Vaulted entry way

See how to measure height of porches & entry features in Figs 6-8 on pp. 11-13



B Roofed entry way
(not vaulted)

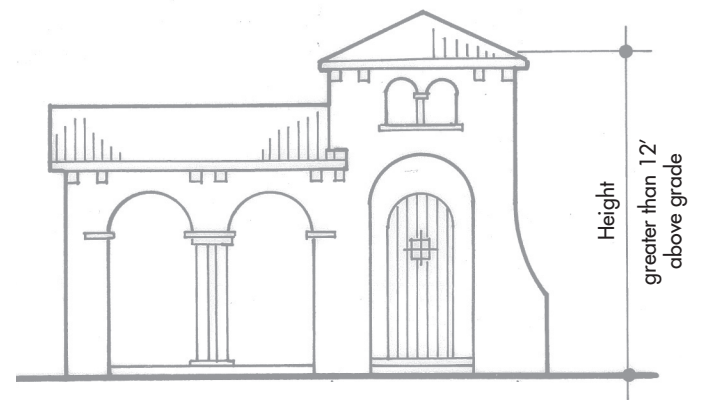

D Combination porch & vaulted entry way

Roofed porches on the 1st floor

Roofed porches on the 1st floor do NOT count toward the gross floor area if at least 50% of the perimeter is at least 50% open.

How to determine if a porch is at least 50% open (using Fig 5 as an example)

Fig 5 Roofed 1st floor porch

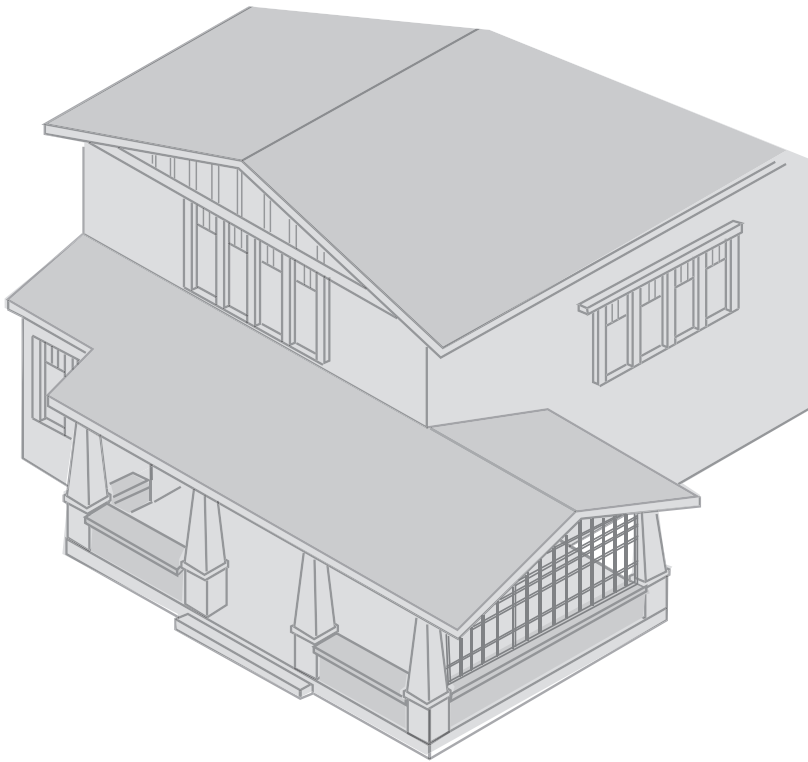

Step 1: Determine the perimeter of the porch and divide it into segments that will allow a comparison of closed and open segments.

The perimeter of the porch in Fig 5 is shown below. It is the sum of segments **A** through **G**. It is 70 linear feet.

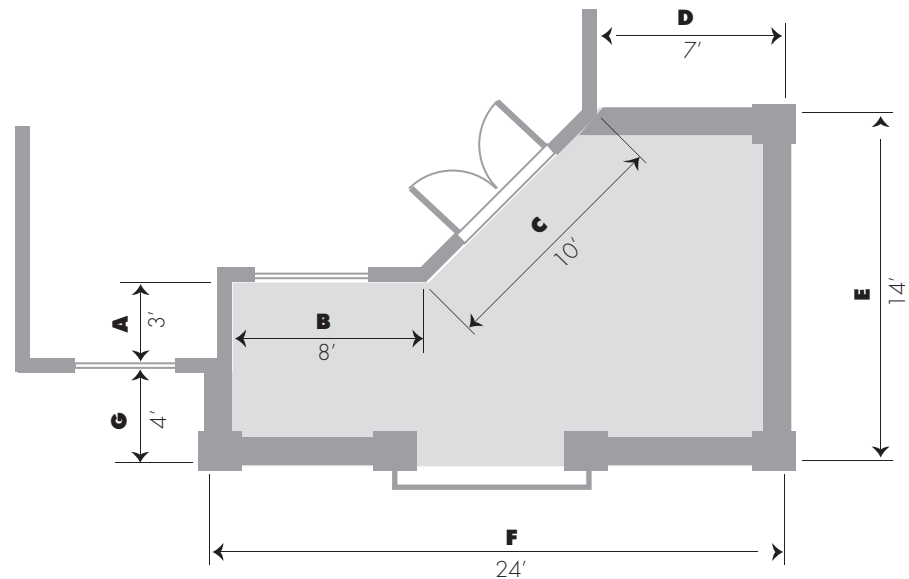

Step 2: Determine which perimeter segments about the house walls. These are closed segments, or sides.

In *Fig 5* sides **A**, **B**, & **C** about the house walls. These are considered to be closed segments.

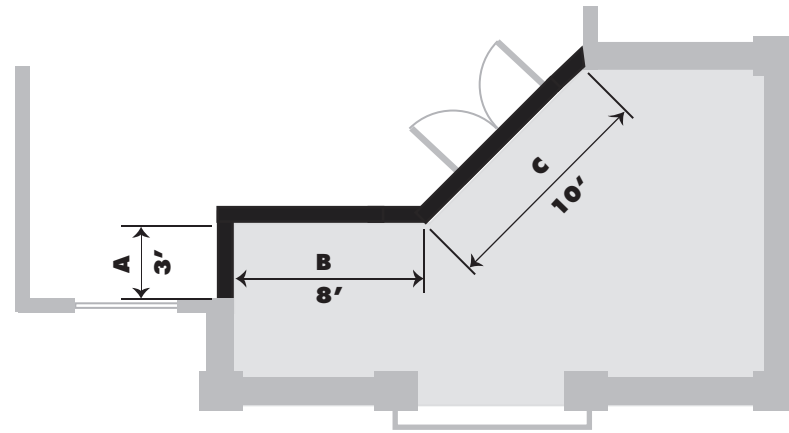

Step 3: Determine the status (open/closed) of the remaining segments based on the design. If at least 50% of the facade area is open, then the segment or side is considered open.

For purposes of assessing the openness of the facade:

- The height of the segment facades is measured from the top of the porch floor to the the point where the segment facade intersects with the top of the roof material.
- The widths of the segment facades are measured from the same plane. Allowances may be made for structural supports that are not excessive.

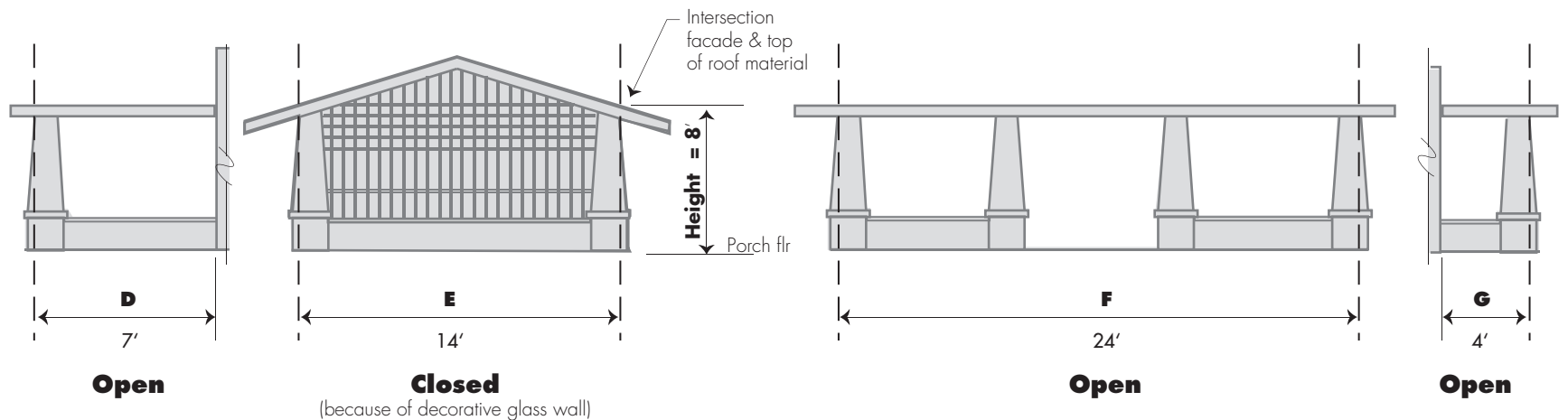

Step 4: Finalize the determination of which segments are closed and which are open, total the linear feet in each category, and compare the totals.

For the porch in *Fig 5*, the summary is as follows:

Closed		Open	
Segment	Feet	Segment	Feet
A	3'	D	7'
B	8'	F	24'
C	10'	G	4'
E	14'		
	<u>35'</u>		<u>35'</u>

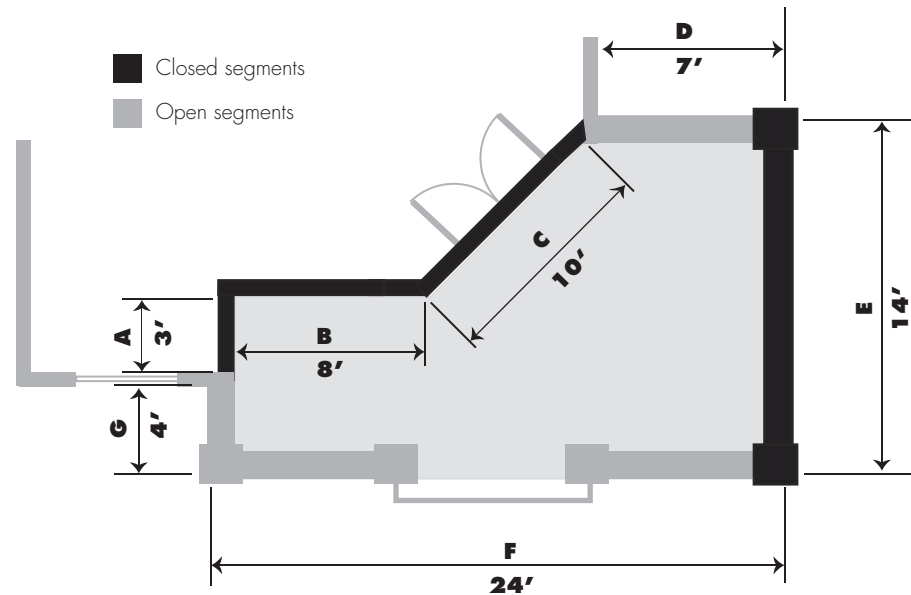

Conclusion: The perimeter of the porch in *Fig 5* is 50% open and so the porch would **NOT** count toward gross floor area

Note: If a porch floor is more than 30" above grade, the porch sides may need to be 36" high for safety reasons. This may cause the porch facade to be considered closed. Possible solutions to make sure the porch sides are considered open are illustrated to the right:

- Railings (ballisters) instead of solid half walls.
- A single safety rail above lower, solid half walls.

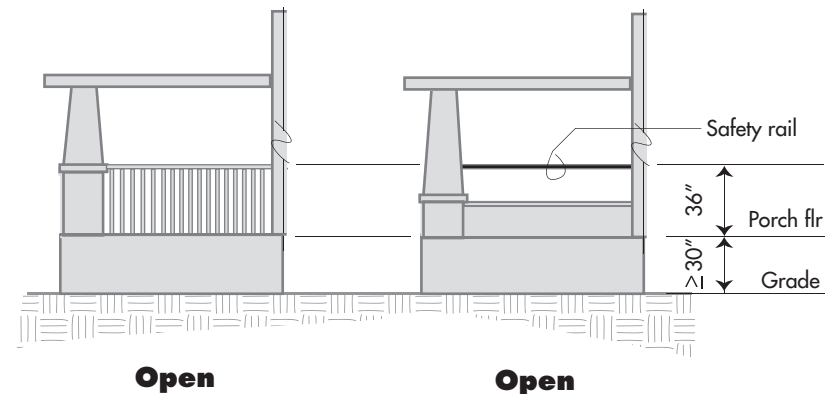

Vaulted entry features

Entry features that are greater than 12' high are called "vaulted entry features". The footprint of such features count twice toward gross floor area regardless of the design (including whether or not they are open) .

How to measure the height of an entry feature in order to determine whether or not it is considered to be a vaulted entry feature (using Fig 6 - 8 as examples)

Fig 6 Entry feature with shed roof

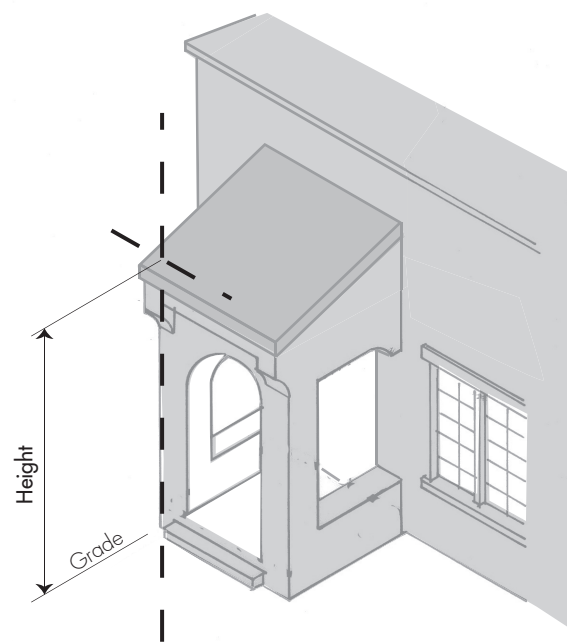

Isometric View

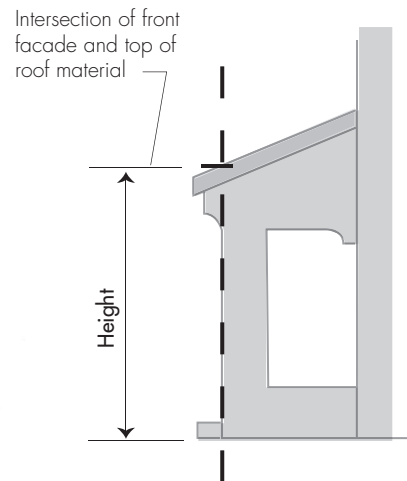

Side Elevation

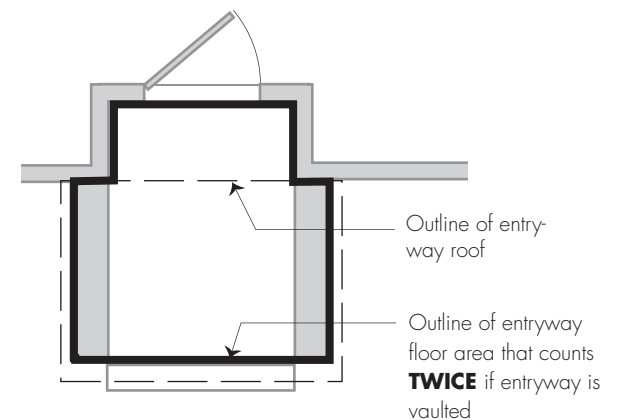

Porch Floor Plan

Note: If the entryway is considered to be a vaulted entryway the area will be counted as follows:

- In this example, a portion of the entryway is recessed beyond the house facade and roof. It is included in the area that counts.
- The area is measured to the outside material of the entryway feature.
- The area counts **TWICE** toward gross floor area.

Fig 7 Entry feature with gabled roof

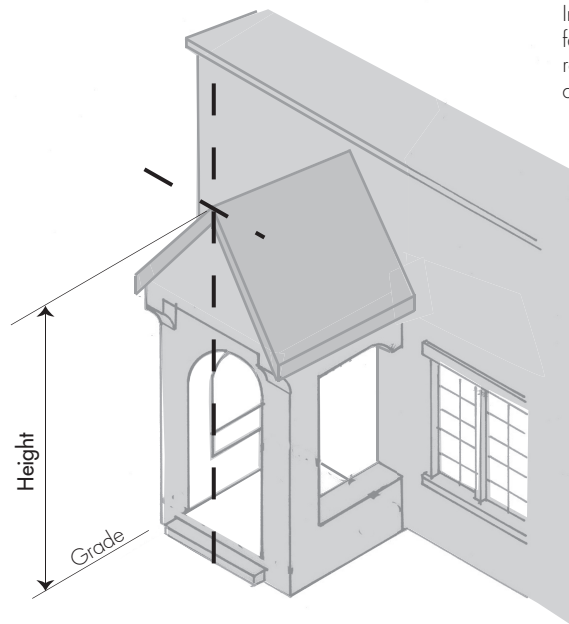

Isometric View

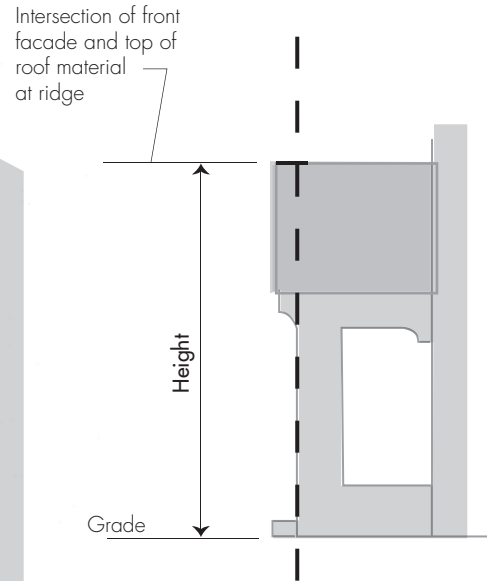

Side Elevation

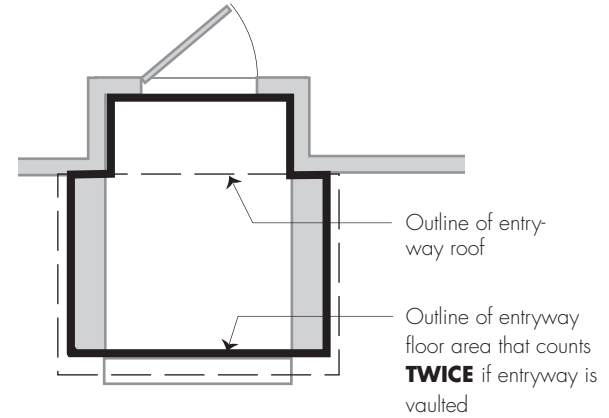

Porch Floor Plan

Note: If the entryway is considered to be a vaulted entryway the area will be counted as follows:

- In this example, a portion of the entryway is recessed beyond the house facade and roof. It is included in the area that counts.
- The area is measured to the outside material of the entryway feature.
- The area counts **TWICE** toward gross floor area.

Note: The 2nd floor over a vaulted entry will count as usual. Therefore, the area will count three times toward gross floor area.

Fig 8 Entry feature with 2nd floor above

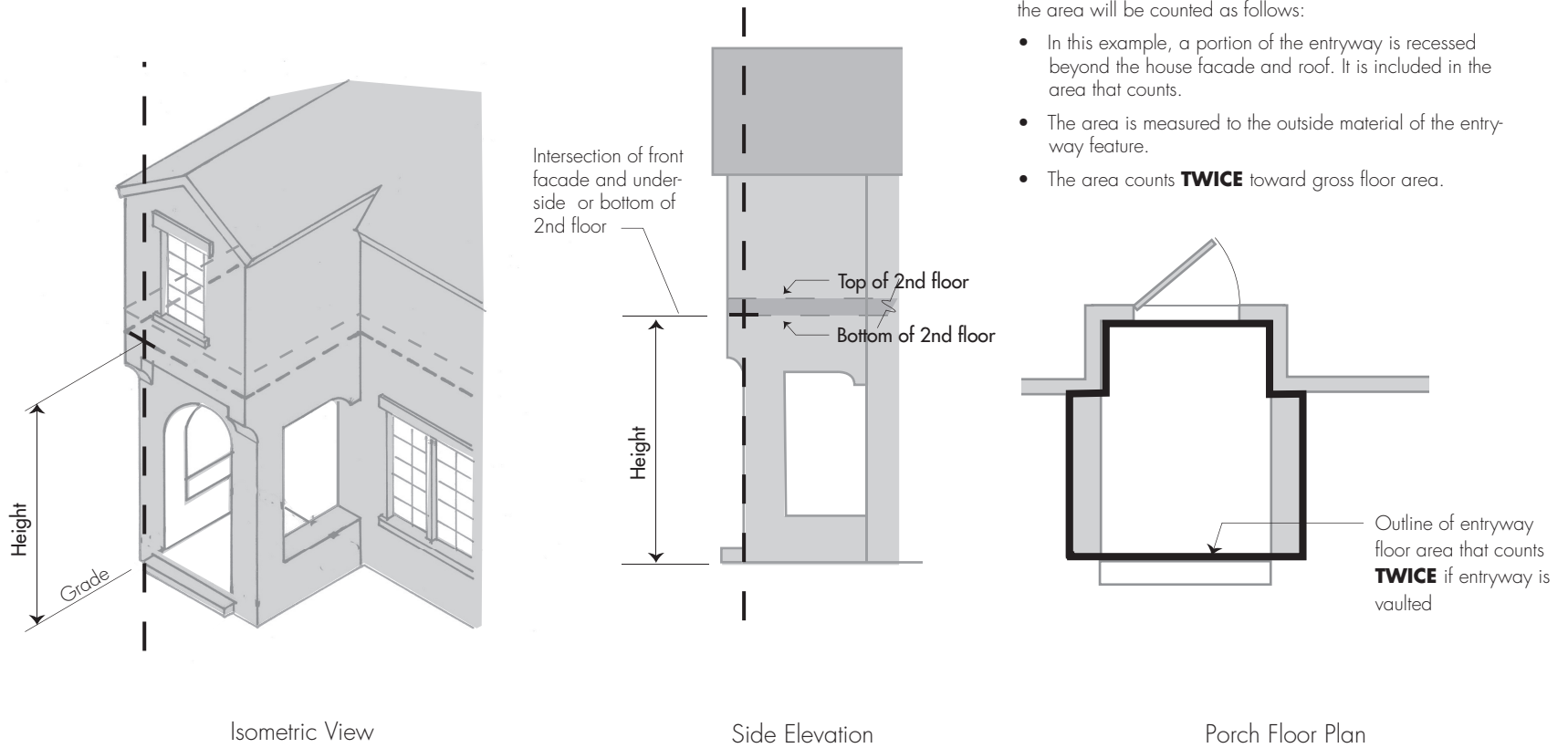

Recessed porches on the 1st floor

Height, depth, and openness of a recessed porch determine whether or not it counts toward gross floor area.

Recessed porches on the ground floor do **NOT** count toward gross floor area if **ALL** the following criteria apply:

- Depth of porch is less than 10' and,
- Porch ceiling is below 2nd floor and,
- Exterior side is substantially open.

Note: It is the city's policy to consider one-story construction to be construction less than 17' above finished floor. If the porch space is higher, the area will count again as 2nd story equivalency.

Fig 9 Recessed porches on the 1st floor

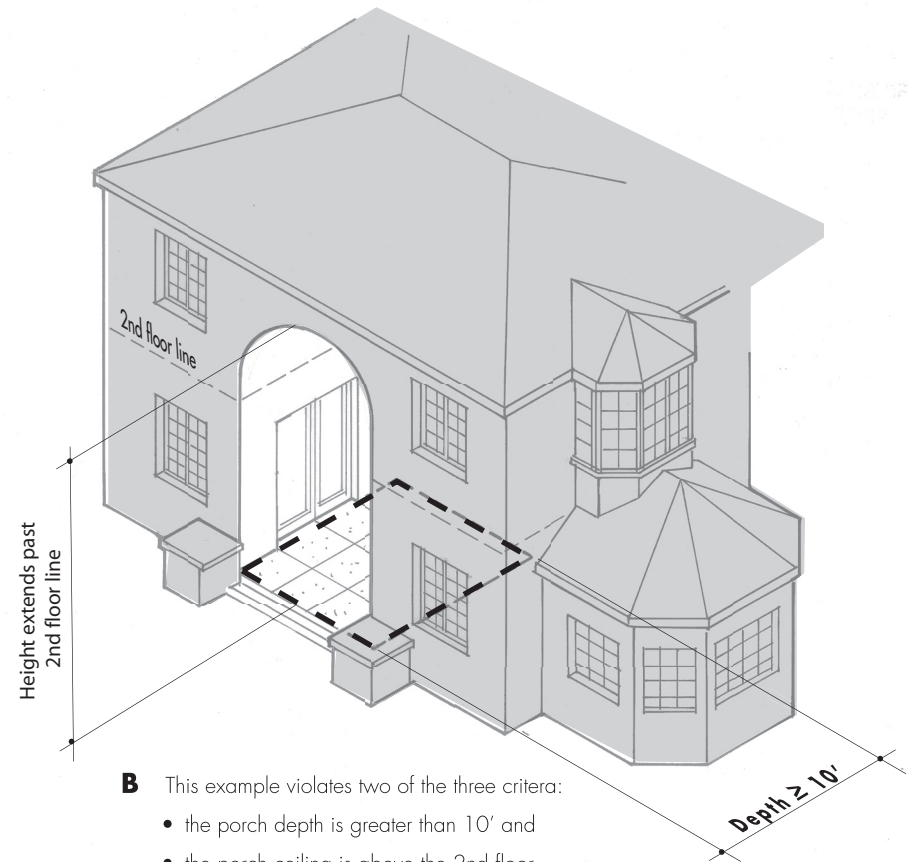
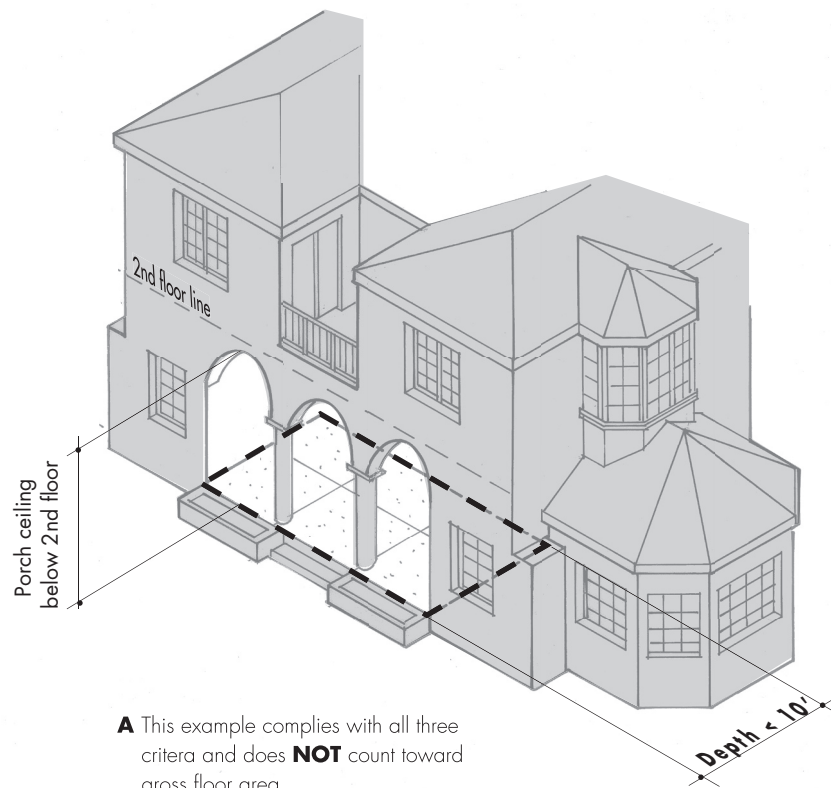

Balconies, decks, & outdoor areas on upper floors

Outdoor areas on upper levels that are roofed DO count toward gross floor area regardless of the design (including whether or not the sides are open).

An outdoor area on an upper floor is considered to be roofed if the eave over that area is deeper than the eave over the rest of the building. This may be illustrated by comparing Roof Plans 1 & 2 of Fig 10.

Fig 10 Balconies

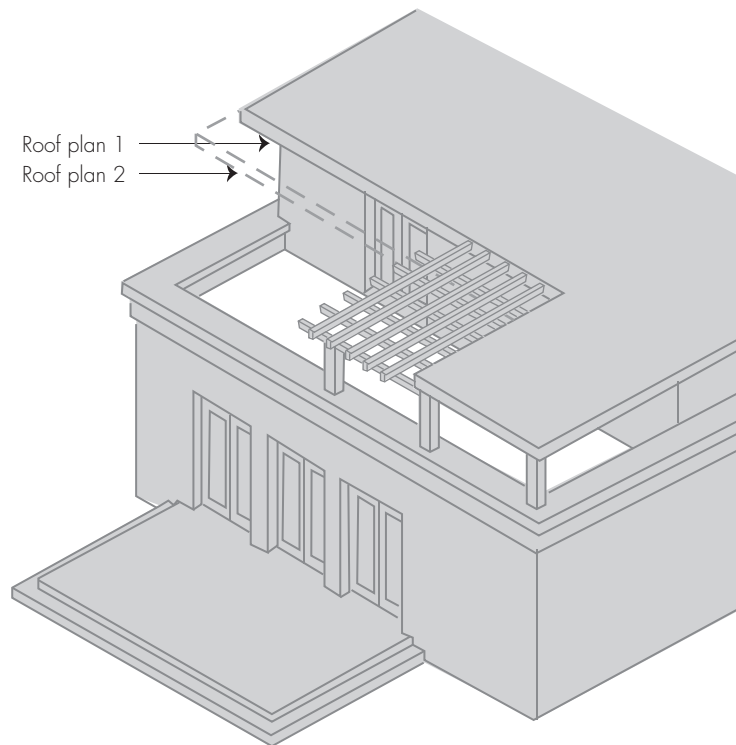

Note: Pop-out balconies are subject to the same evaluation.

Roof Plan 1
Area A: Counts because it is roofed
Area B: Does not count because this arbor is substantially open
Area C: Does not count because the overhang is the same size as the overhang around the rest of the house and is considered to be open

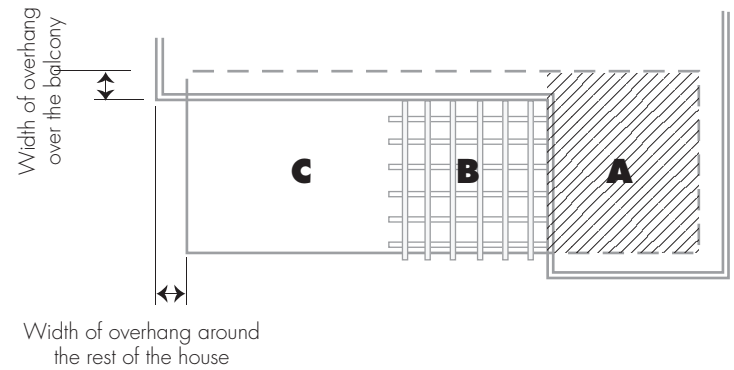

Roof Plan 2
Area A: Counts because it is roofed
Area B: Counts because the overhang here is greater than the overhang around the rest of the house, and considered to be roofed
Area C: Does not count because it is open

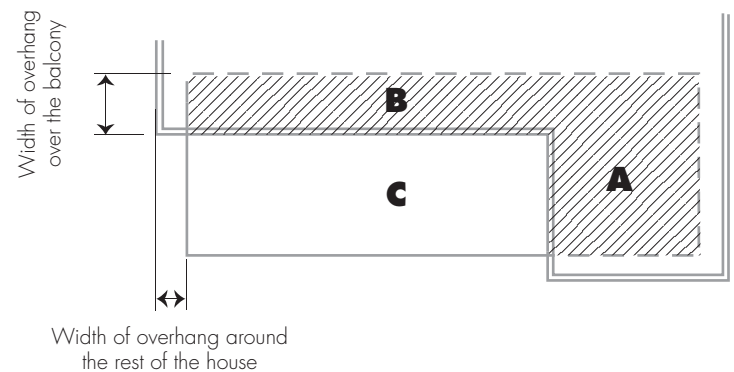

Attic space & equivalencies

Voluminous spaces in a structure contribute to the mass even if these areas are not used or described in the floor plan. The 2nd & 3rd floor equivalency addresses how these areas count toward the gross floor area.

Code sections
18.04.030(a)(65)
18.12.040(b)Table 3

Attic, closet, & perimeter spaces

On all accessible floors, areas with at least 5' of head clearance count toward the gross floor area regardless of the floor plan or actual usage of the space.

In Fig 11 below, the highlighted areas count as follows:

- **Area A** of this 3rd floor (accessible via stairs), has 5' of head clearance and counts as 3rd floor area.
- **Area B** of this 2nd floor (accessible via stairs), has 5' of head clearance and is included in the count of the, more obvious, 2nd floor area.

Note: 500 sf of unusable attic space may be exempted for Category 1 & 2 historic homes.

Fig 11 Attic, closet, & perimeter spaces

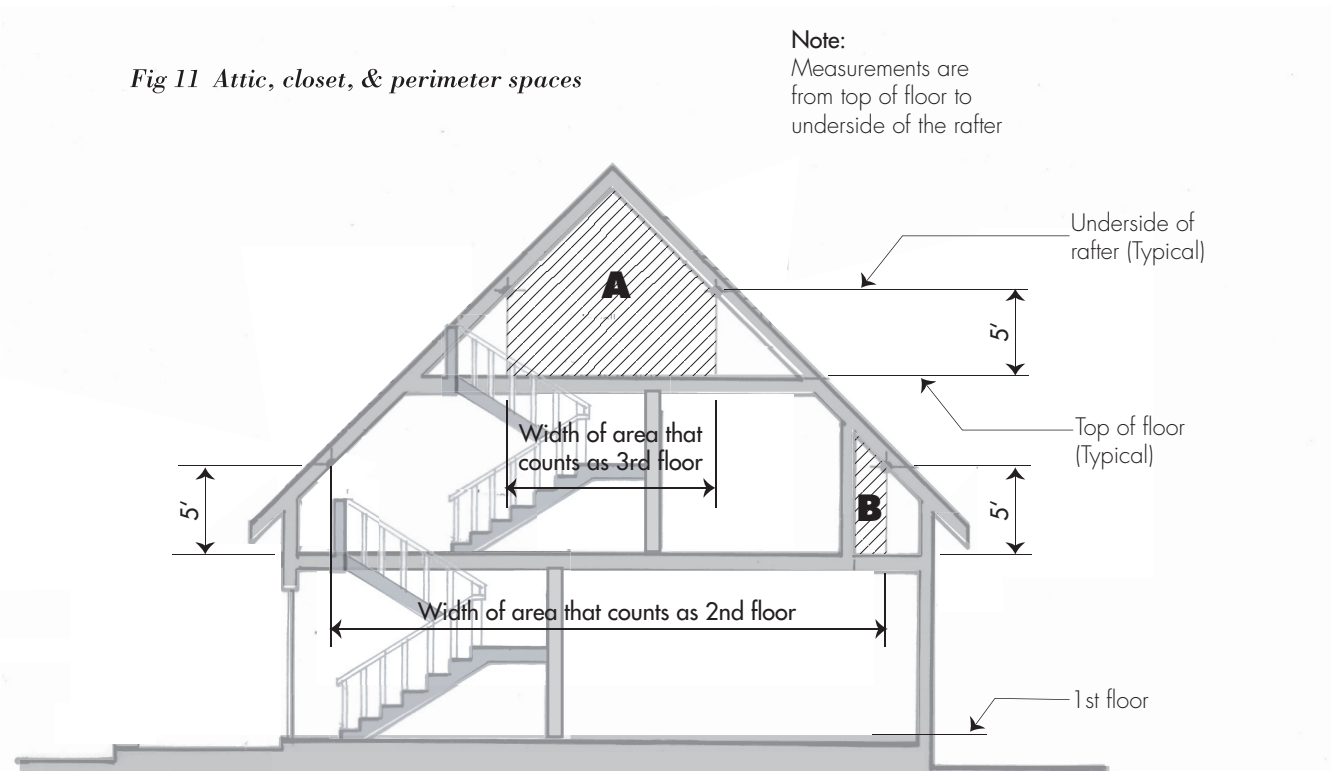

2nd & 3rd floor equivalency

Areas higher than 17' and 26' above the first floor (that do not already count as floor area e.g., open atrium spaces and inaccessible attic spaces), count toward the gross floor area in the form of 2nd and 3rd floor equivalency regardless of the floor plan or usage of the space. Stairwells will be measured the same way that vaulted ceiling spaces are measured.

In the examples of Fig 12 below the highlighted areas count as follows:

Area A

- once as 1st floor,
- again as 2nd floor, and
- a third time as 3rd-floor equivalency

Area B

- once as 1st floor,
- again as 2nd-floor equivalency

Note: 200 sf of 3rd floor equivalency may be exempted where roof pitch is 4:12 or steeper (see "Height" section).

Fig 12 2nd & 3rd floor equivalency

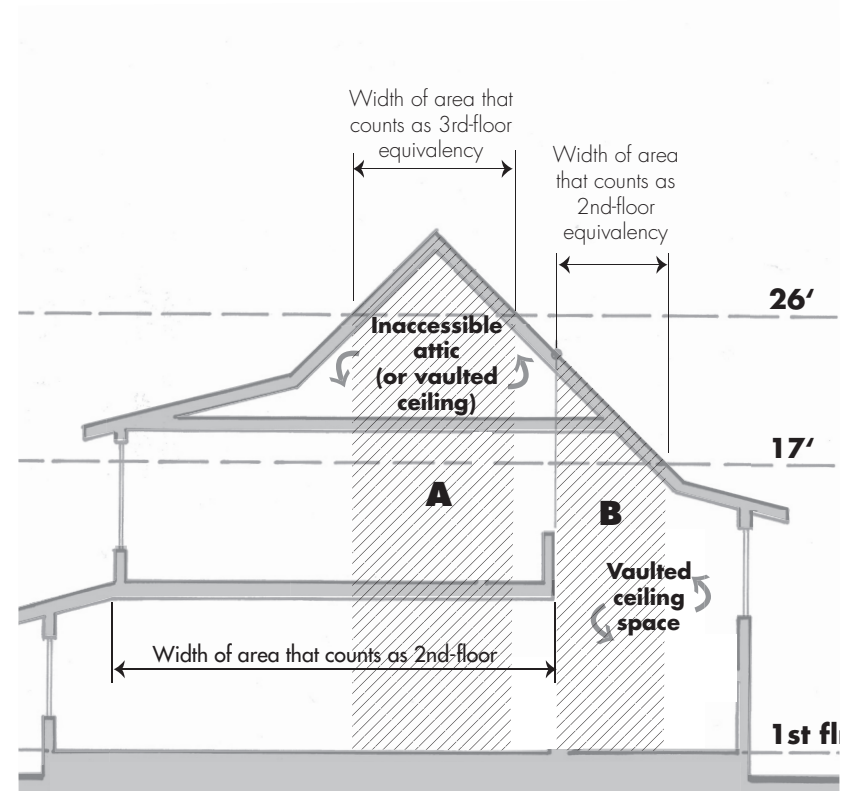
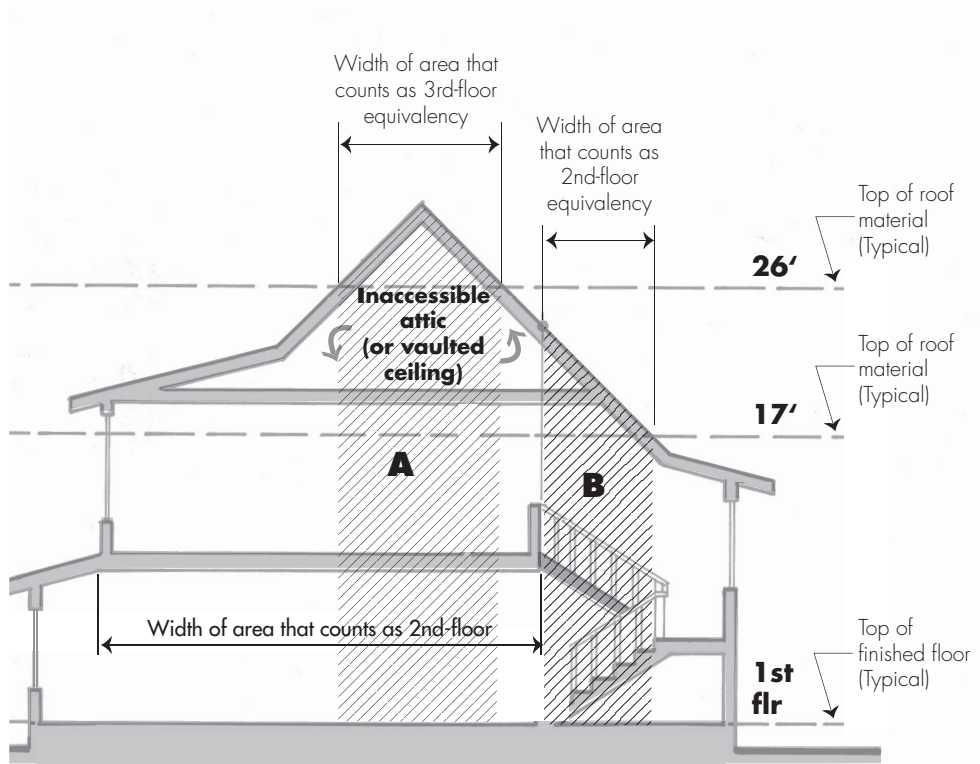

Projections

Architectural relief features such as bay windows are pleasant additions to a house design and are encouraged. If they meet certain design criteria they do not count toward gross floor area.

Code sections
 18.04.030(a)(65)
 18.12.040(b)Table 3

Bay windows

Bay windows that meet the design criteria below are considered to be decorative architectural features and do NOT count toward gross floor area.

Design criteria for bay windows that do not count:

- Bottom of feature must be at least 18" above the floor joists
- Exterior supports must be features like corbels and/or brackets rather than solid walls
- At least 50% of the surface is glass

Note: Bay windows that extend higher than the structure's roof are considered to be dormers and count toward gross floor area.

Fig 13 Bay windows

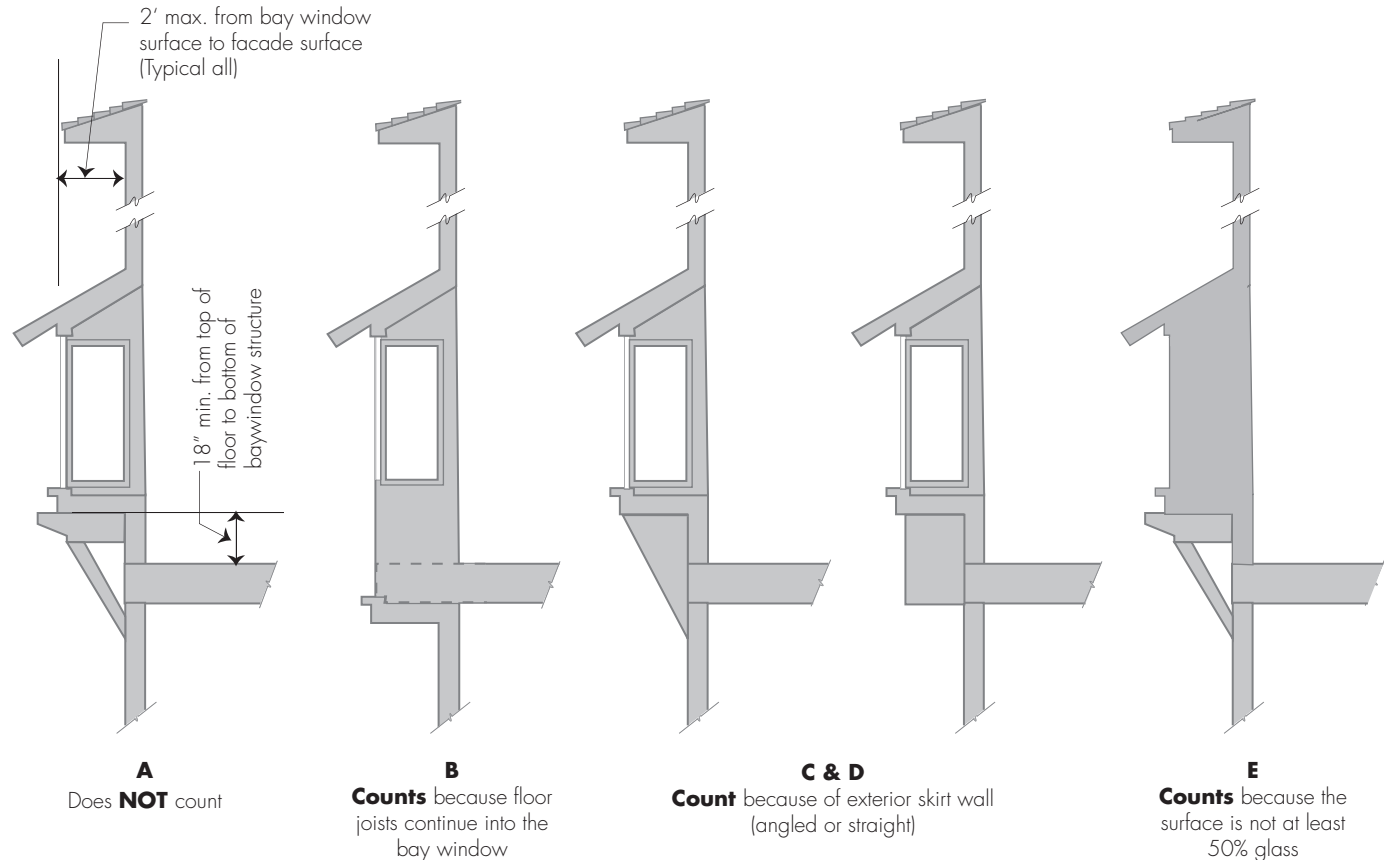

Fireplaces, chimneys, sheds, planters, and other projections

- Fireplaces shall be included in the gross floor area (counted one time) regardless of configuration or design.
- Sheds, planters, and other projections that are higher than 5' count toward gross floor area regardless of configuration or design.

Fig 14 Fireplaces, chimneys, sheds, etc.

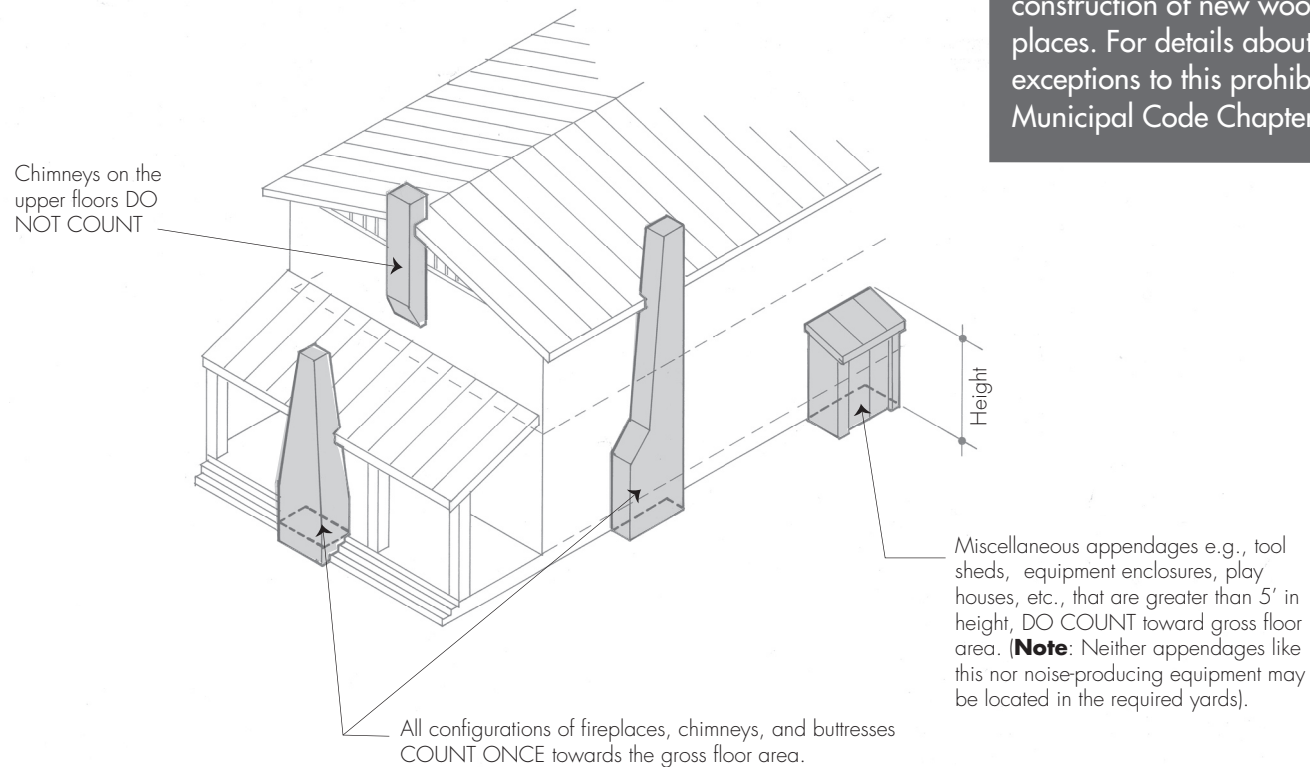

Note: In 2000, the city of Palo Alto passed an ordinance prohibiting the construction of new wood-burning fireplaces. For details about and possible exceptions to this prohibition, see the Municipal Code Chapter 9.06.030

Note: Fireplaces not connected to the house are treated like accessory structures, they and count towards FAR if they are greater than 120 sf. They count towards lot coverage always, regardless of size.

Setbacks

Setbacks apportion a lot into two parts:



- **buildable area** (in the middle)
- **required yards** (surrounding the building area).

These required yards, meant to be maintained as open space areas, are important as landscaping opportunities to keep our neighborhoods attractive as well as for the preservation of privacy.

Code sections

Page 20
18.12.040 (a) Table 2
18.12.040 (a,c,e,& i)

Page 21
18.04.040 (e)

Page 22–23
18.040.030 (84, 87, 91, 128, & 146)

Page 24–25
as shown in table

Standard setbacks

Standard setbacks apply in most cases.

Standard setbacks by zone

Zone District	Front ^{*✱}	Rear	Interior Side	Street Side [*]
R-1	Contextual or 20	20	6	16
R-1(7000)	Contextual or 20	20	8	16
R-1(8000)	Contextual or 20	20'	8	16
R-1(10000)	Contextual or 20	20	8	16
R-1(20000)	Contextual or 20	20	8	16
Flag lot	10	20	see zone	na
Substandard lot	Contextual or 20	20	see zone	16
Substandard corner lot < 50' wide	Contextual or 20	20	see zone	10

✱ For front setback, if contextual setback is greater than 30' then it applies—otherwise, the 20' setback applies.

* For front & street side setbacks a special setback may apply. If both a contextual and special setback apply, the greater of the two setbacks is required.

Special setbacks

Special setbacks override standard setbacks unless a larger contextual setback applies.

Streets w/special setbacks

Alma St	Embarcadero Rd	Middlefield Rd
Arastradero Rd	Guinda St	Miranda Ave
Ash St	Hamilton Ave	Newell Rd
California Ave	Hanover St	Oak Hill Ave
Channing Ave	Lincoln Ave	Page Mill Rd
Charleston Rd	Loma Verde Ave	Park Blvd
Churchill Ave	Louis Rd	Stanford Ave
Colorado Ave	Lytton Ave	University Ave
East Meadow Dr	Manuela Ave	West Meadow Dr
El Camino Real	Mesa Ave	

Special setback distances can be found on:

- pages of the city's zone-map booklet (available both online and in hardback at the Development Center)
- parcel reports from the city's GIS (available at the Development Center)

Contextual front setbacks

Contextual setbacks apply if, and only if, the average of the existing setbacks on the same side of the block is 30' or greater.

How to determine if a contextual setback applies using Fig 15 below, as an example.

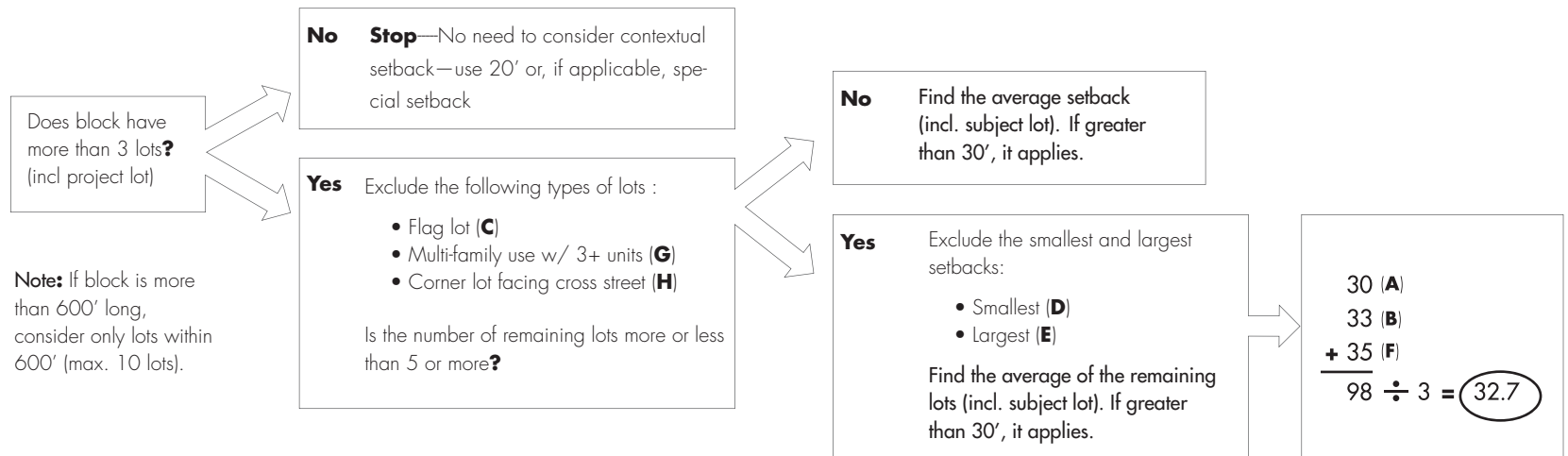
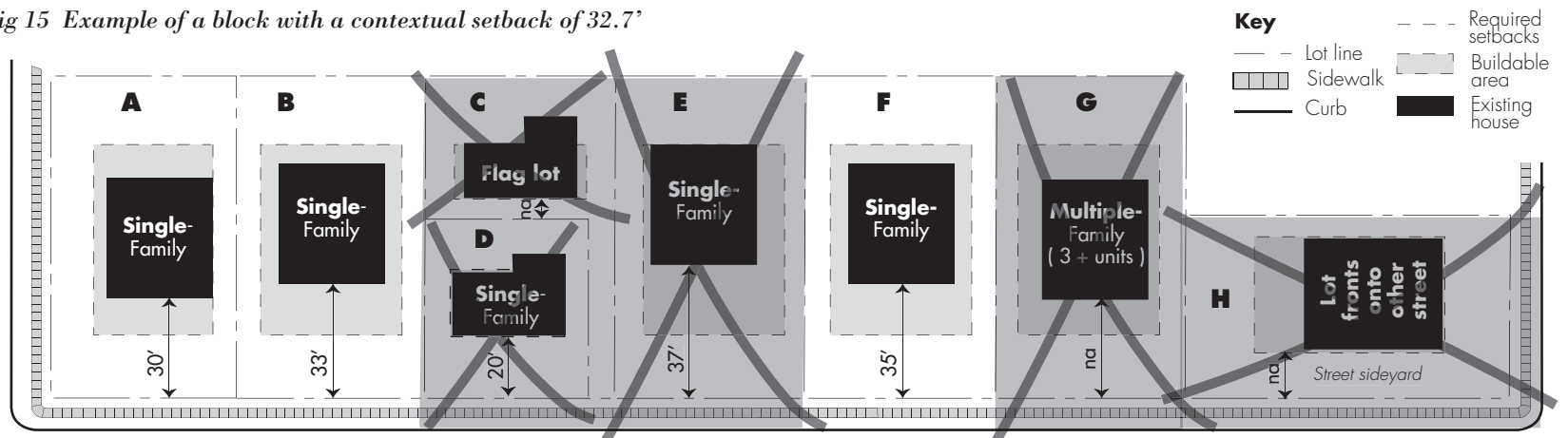

Fig 15 Example of a block with a contextual setback of 32.7'



Setback considerations

Easements

Some easements affect setbacks i.e., setbacks must be measured from the edge of the easement regardless of the lot line as illustrated in *Fig 16 on this page*. Easements that affect setbacks are:

- Creek easements
- Public street easements

Note: most public utility easements do not affect setbacks.

Sidewalks

The sidewalk may not indicate the lot line. Often, the street easement or public right-of-way extends for several feet beyond the sidewalk. *Fig 16 on this page* illustrates this common circumstance and how the setbacks are affected i.e., they must be measured from the lot line regardless of the sidewalk.

Oddly shaped lots

For some lots, the setbacks and required yards may not be obvious .

Fig 17 on page 23 indicates the appropriate site plan for lot shapes about which questions often arise:

- flag lot (*Fig 17 A*)
- corner lot (*Fig 17 B*)
- through lot (*Fig 17 D*)
- wedge-shaped lot (*Fig 17 E*)
- lot with more than four sides (*Fig 17 F & G*)

Flag & substandard lots

Fig 17 on page 23 also illustrates examples of setbacks that have been reduced for smaller or oddly shaped lots e.g.,

- the front setback of a flag lot (*Fig 17 A*)
- the street-side yard setback for substandard corner lots that are less than 50' wide (*Fig 17 C*)

Fig 16 Setbacks: easements and sidewalks

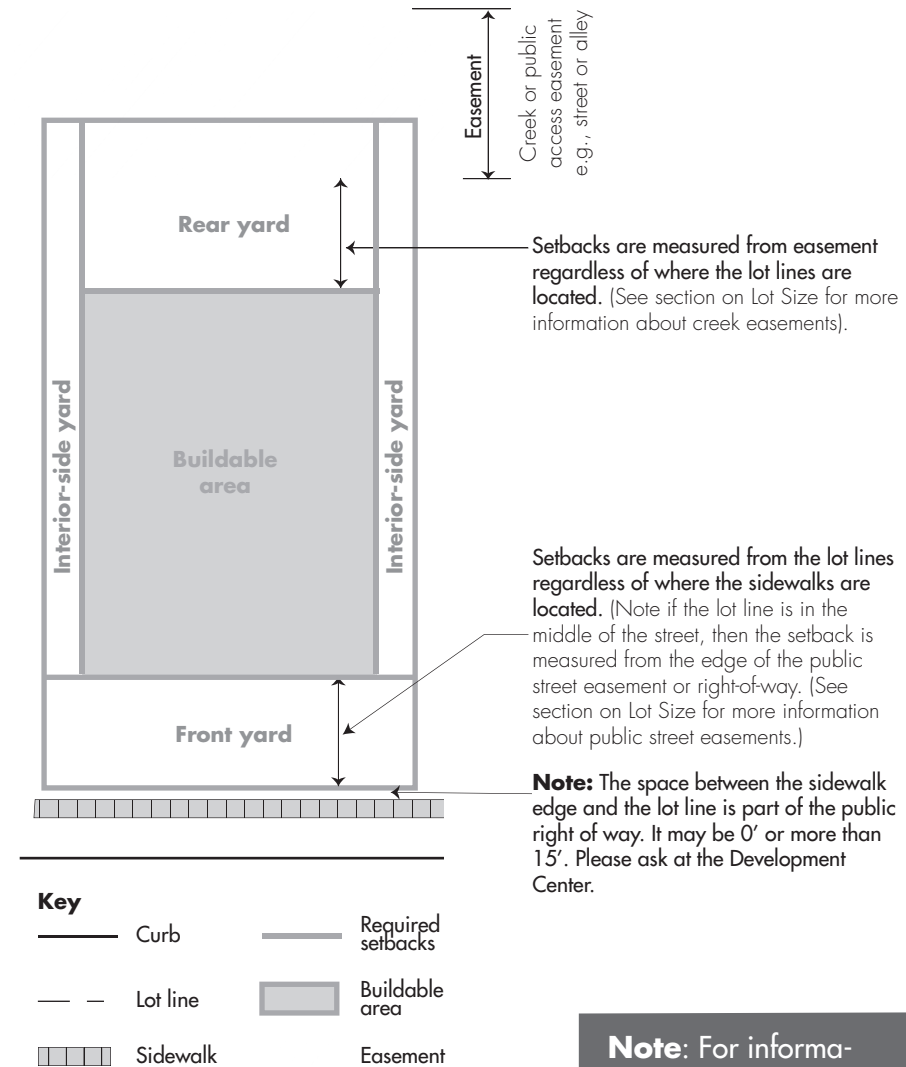

Note: For information regarding creek easements, contact the Santa Clara Valley Water District

Determining setbacks on oddly shaped lots considerations

Fig 17 Setbacks for oddly shaped lots

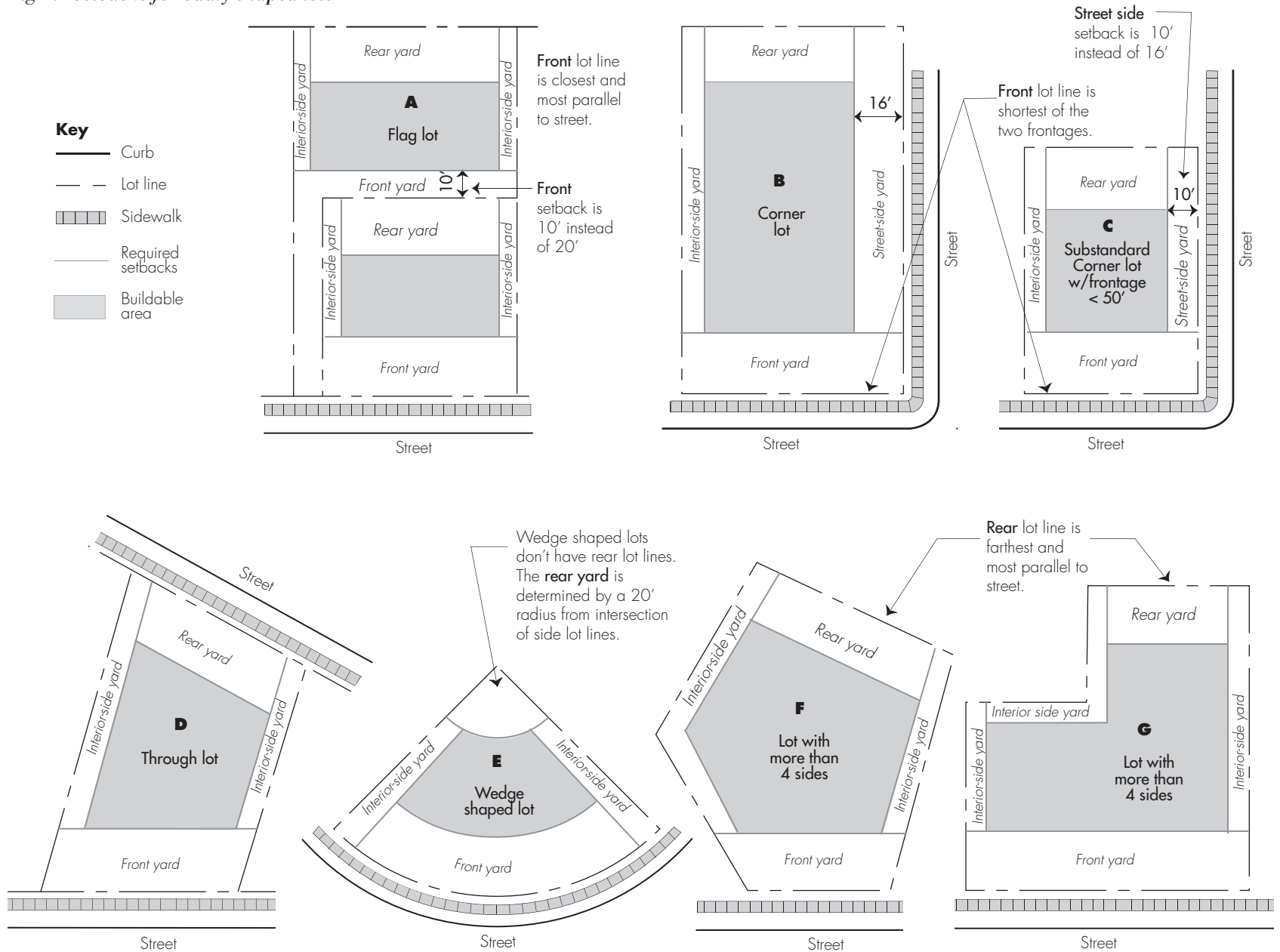

Allowable setback encroachments summary

Feature	Allowable encroachment	Code Sec	Illustration
Main dwelling			
• 1st floor portion at rear of structure \leq half width of structure	to within 14' of rear lot line	18.12.050 (a)(2)	Fig 18 on this page
• 1st floor extension of an existing front setback encroachment	to within 14' of front lot line	18.12.050 (a)(1)(A)	Fig 19 p. 25
• 1st floor extension of an existing interior-side setback encroachment	to within 5' of interior-side lot line	18.12.050 (a)(1)(B)	Fig 19 p. 25
• 1st floor extension of an existing street-side setback encroachment	to within 10' of street-side lot line	18.12.050 (a)(1)(C)	Fig 19 p. 25
• Attached storage closets \leq 6' in height & \leq 25 sf	4' into front & rear yards & 2' into side yards		
Detached accessory structures			
• that are 75' from front lot line and 20' from street-side lot line	in rear or side yards	18.12.080 (b)(3)	Fig 34 p. 39
• that are for covered parking and on lots \leq 95' deep and 25' from street-side lot line and in rear half of lot	in rear or side yards		
Porches and entry features			
• 1st floor balconies, uncovered porches, stairways, and fire escapes	6' into front & rear yard & 3' into the side yards	18.12.050 (a)(3)(D)	
• 1st floor only canopies & patio covers	rear or side yards	18.12.050 (a)(3)(E)	
Other			
• Eaves & cornices	2' into side & 4' into front & rear yards	18.12.050 (a)(3)(A)	
• 1st floor bay / greenhouse windows composed of a window surface & cantilevered with no floor joists.	2' into front yard & 3' into rear yard	18.12.050 (a)(3)(B)	
• Greenhouse windows only	2' into side yards		
• Uncovered parking	in rear or side yards except for 1st 10' of street side yard	18.12.060 (.c)	Fig 34 p. 39
• Pools & spas (not equipment)	to within 6' of rear & interior-side lot lines		
• Fireplaces \leq 5' wide	2' into side yard		
Excavated features			
• Lightwells and stairwells	3' into side yards & 4' into rear yard (cumulative length \leq 15')	18.12.090 (c)	Fig 39 p. 42
• Below grade patios	2' into side yards & 4' into rear yard (cumulative length \leq 5')		Fig 40 p. 43

Allowable rear encroachment

Fig 18 Allowable encroachment: rear yard

Rear yard encroachment

A portion of the main dwelling (no wider than half the max. width of the dwelling), may encroach into the rear setback, at the ground floor only, as follows:

- For all lots except back-to-back corner lots, up to 6', providing a minimum setback of 14' is maintained.
- For back-to-back corner lots, up to 10', providing a minimum setback of 10' is maintained.

Note:

- Multiple protrusions are not permitted; addition must be contiguous with existing protrusion.
- Only for legally constructed structures (no variance or an home-improvement exception (HIE)).
- Only once in the life of the structure.

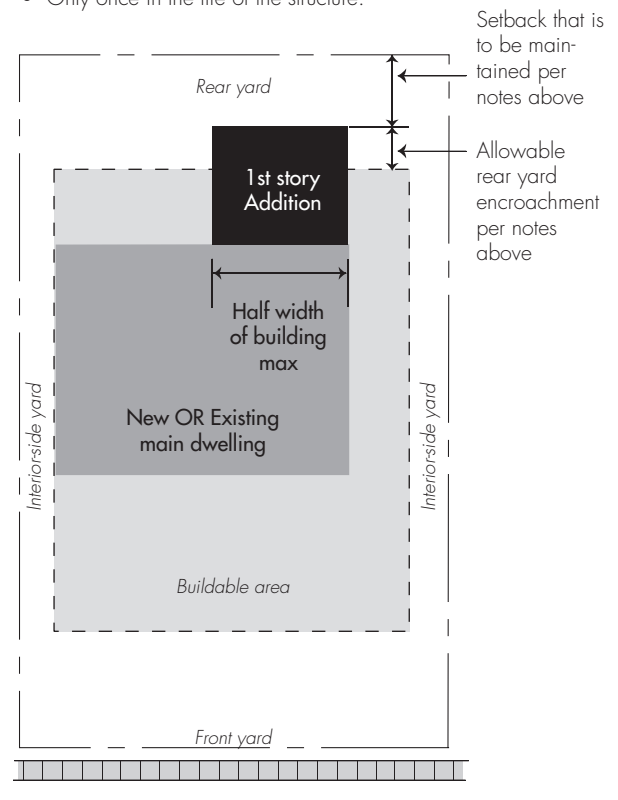

Allowable extensions to existing encroachments

Fig 19 Allowable extensions of existing walls that encroach into required yards (on ground floor only)

A Extension of existing side yard encroachment

An existing wall that encroaches into the required interior side yard setback but is at least 5'-0" from the property line, may be extended at the same setback, in one direction only, at the ground floor only, for a distance equal to the length of the existing wall or 20' whichever is less.

Note: In the example below, two existing walls are encroaching--only one of them may be extended.

B Extension of existing front yard encroachment

An existing wall that encroaches into the required front yard setback but is at least 14'-0" from the property line, may be extended at the same setback, in one direction only, at the ground floor only, with both of the following provisions:

- 1) the length of the extension is no greater than that of the existing encroaching wall,
- 2) the combined length is no greater than one-half the maximum width of the house.

C Extension of existing street-side yard encroachment

An existing wall that encroaches into the required street side yard setback but is at least 10'-0" from the property line, may be extended at the same setback, in one direction only, at the ground floor only, for a distance equal to the length of the existing wall or 20' whichever is less.

Note:

- Encroaching walls that don't meet the minimum setback given for each case i.e., 5', 14, and 10', may not be extended nor may they may not be stepped back and then extended.
- Multiple protrusions are not permitted; addition must be contiguous with existing protrusion.
- Only for structures that were legally constructed, without a variance or an home-improvement exception (HIE).
- Only once in the life of the structure.
- Requires retention of the non-complying wall.
- Exceptions apply to special setbacks as well.

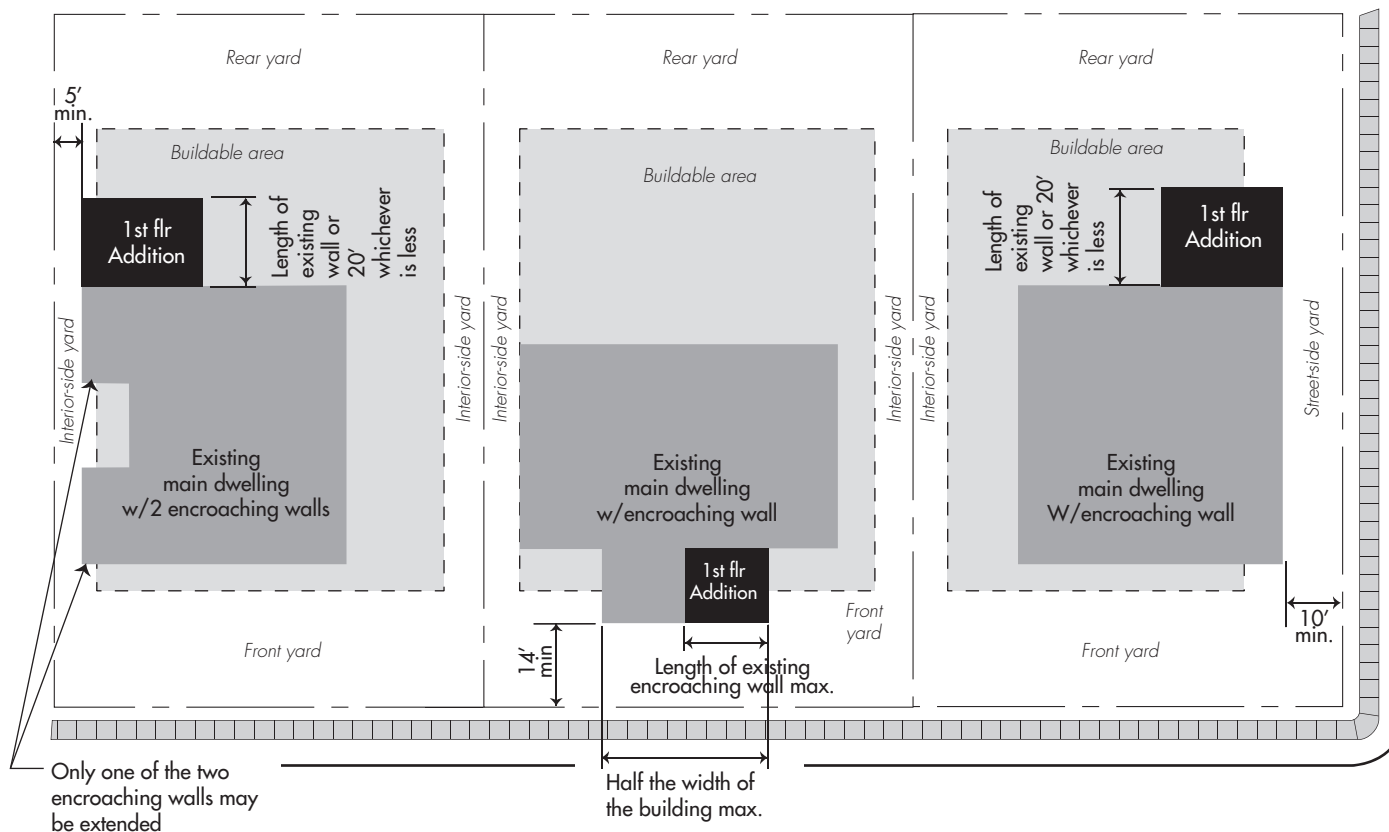

Key

- Lot line
- - - Required setback
- Buildable area
- Sidewalk
- Existing house
- Addition

Daylight plane

The daylight plane in conjunction with the setbacks & height limits, create an invisible tent

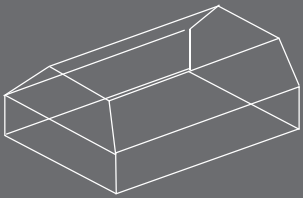

intended to contain development on the lot in a way that preserves privacy and exposure to natural light.

Code sections

Page 26

18.12.040 (a) Table 2

Page 27

18.04

Page 28

18.12.040 (c) Table 2

Page 29

18.12.050 (b) (2)

18.12.040 (j)

Primary daylight plane (sides)

The primary daylight plane regulates structures located within the *buildable area*. Structures located in the rear and/or side yards are regulated by the accessory-structure daylight plan described on the next page.

Fig 20 Front elevation showing side primary daylight plane

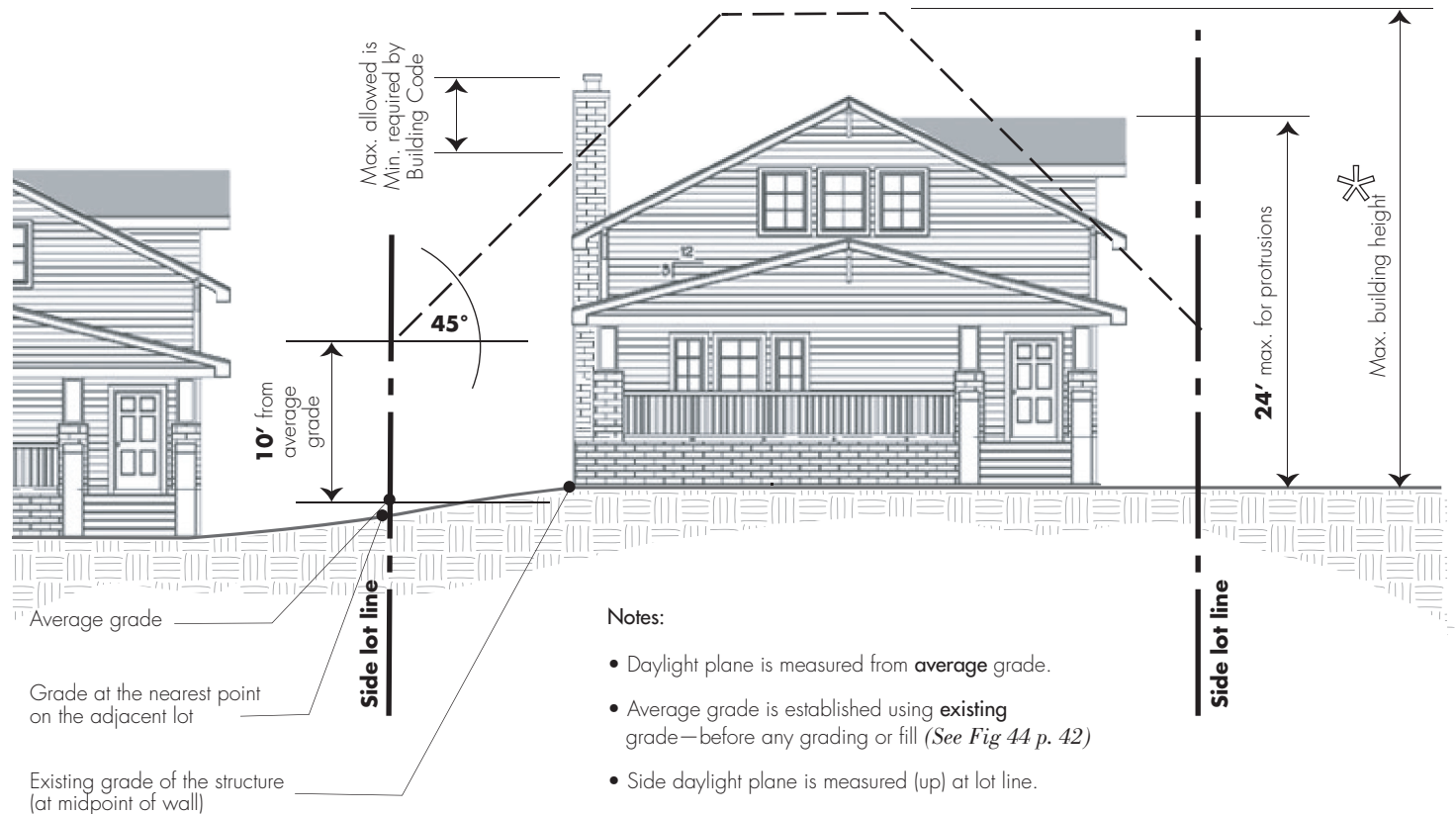

Notes:

- Daylight plane is measured from **average** grade.
- Average grade is established using **existing** grade—before any grading or fill (*See Fig 44 p. 42*)
- Side daylight plane is measured (up) at lot line.
- Rear daylight plane is measured (up) at rear setback.

Fig 21 Plan view showing how to determine average grade

When measuring daylight plane, height is measured from the average of the grade at the midpoint of the building and the grade of the closest point on the abutting site.

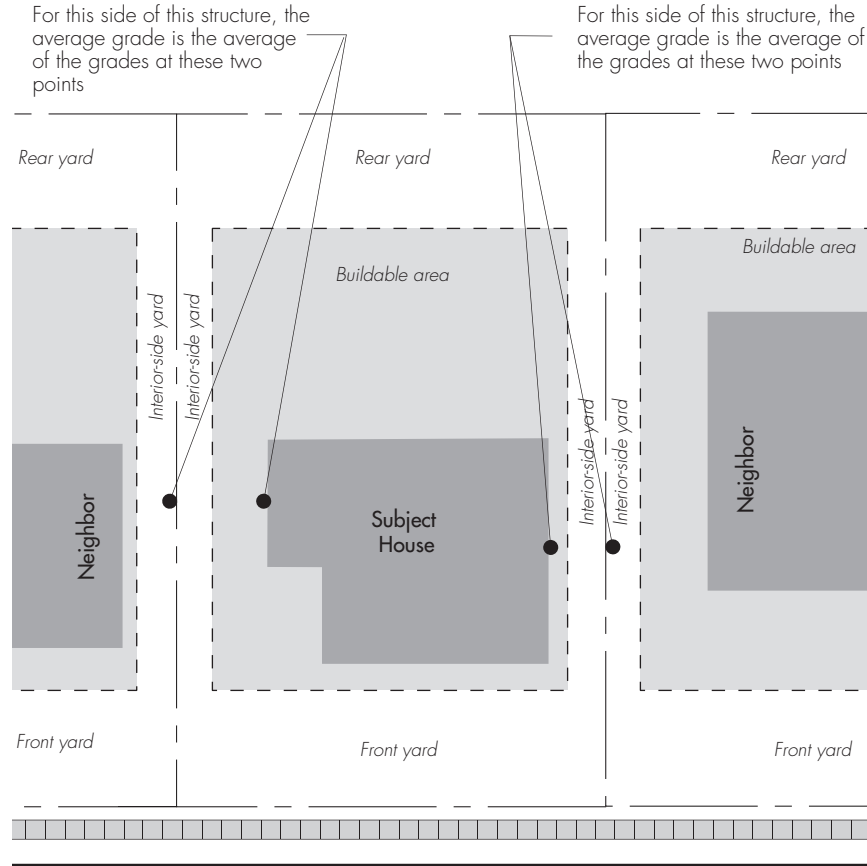

- Key**
- Lot line
 - - - Required setbacks
 - ▨ Sidewalk
 - ▨ Buildable area
 - Existing house

Fig 22 Detail showing allowable eave protrusion

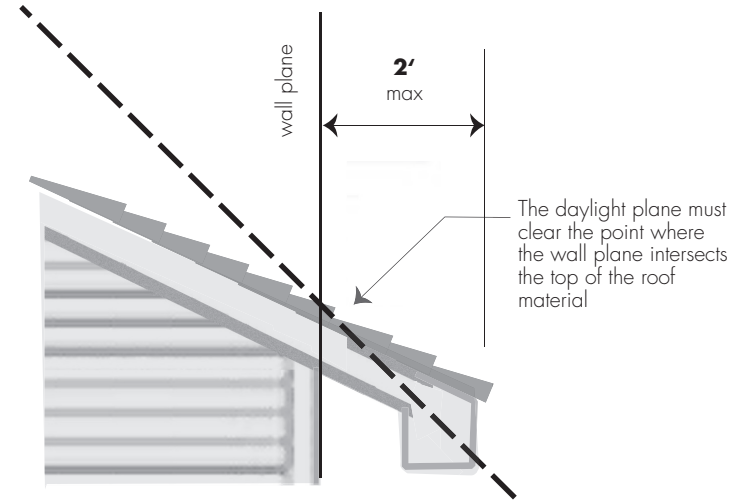

Certification of daylight plane compliance:

Upon request by the building official any person building or making improvements to a structure shall provide a certification that the structure, as built, complies with the daylight plane provisions in Code Section 18.12.040(a). Such certification shall be prepared by a licensed engineer, architect, or surveyor, and shall be provided prior to frame inspection. (Sections 18.12.040(j)).

Primary daylight plane (rear)

Fig 23 Side elevation showing Rear primary daylight plane

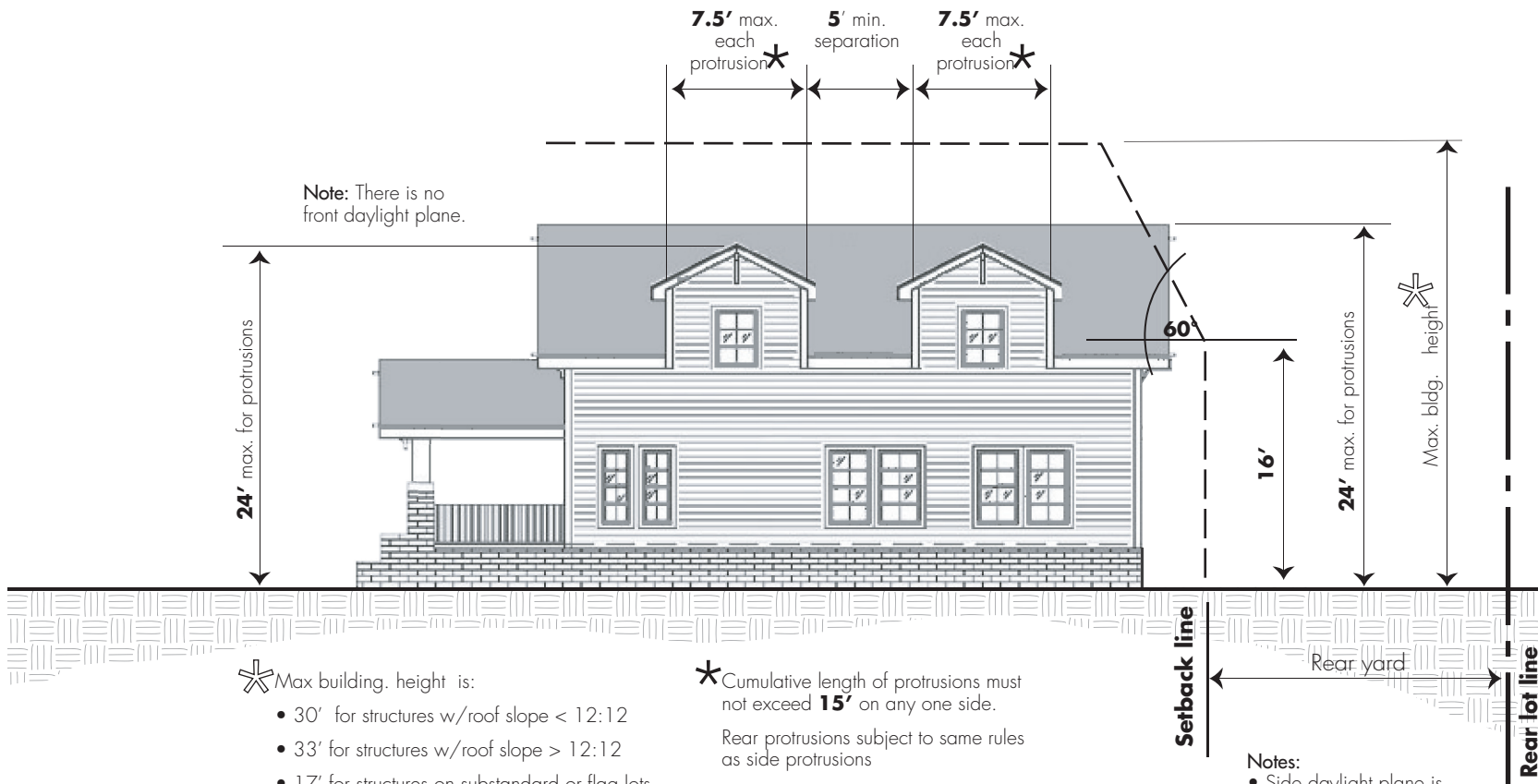

Note: There is no front daylight plane.

24' max. for protrusions

7.5' max. each protrusion *
5' min. separation
7.5' max. each protrusion *

Setback line

16'

24' max. for protrusions

Max. bldg. height *

Rear lot line

Rear yard

- * Max building height is:
 - 30' for structures w/roof slope < 12:12
 - 33' for structures w/roof slope > 12:12
 - 17' for structures on substandard or flag lots regardless of flood plane
 - variable for structures located in flood zones except on substandard and flag lots - up to 33'

* Cumulative length of protrusions must not exceed **15'** on any one side.
Rear protrusions subject to same rules as side protrusions

- Notes:
- Side daylight plane is measured (up) at lot line.
 - Rear daylight plane is measured (up) at rear setback.

Allowable daylight plane protrusions summary

Feature	Allowable protrusion	Illustration
Television and radio antennas	up to 15' above maximum building height	
Chimneys and flues < 5' wide	may extend beyond the daylight plane to meet minimum required clearance of Building Code (Chapter 16.04)	<i>Fig 20 on p. 26</i>
Dormers, roof decks, gables, or similar architectural features	each feature $\leq 7.5'$ long and cumulative length of all features $\leq 15'$ with min 5' separation between features (on each side); height $\leq 24'$;	<i>Fig 20 on p. 26 & Fig 23 on p. 28</i>
Cornices, eaves, and similar architectural features (excluding flat or continuous walls or enclosures usable for interior space)	max 2'	<i>Fig 22 on p. 27</i>

Accessory structures

(other than 2nd-dwelling units)

The code accommodates a wide variety of choices regarding accessory structures while utilizing parameters like setbacks and the daylight plane to preserve the characteristics of a residential neighborhood as well as privacy and daylight to each lot.

Code sections

Page 30–31

18.12.080

Page 32

18.12.080 (b) (4)

Accessory structure standards *(non-dwelling)*

There are no minimum lot size requirements for non-dwelling accessory structures. The regulations are as follows:

All accessory structures...

- Must have a use that is incidental to main dwelling
- Must be detached and at least 3' from main dwelling
- May NOT have a kitchen
- Count toward the total lot coverage
- If over 120 sf, require a building permit and count towards total gross floor area

Accessory structures located in the buildable area....

- Are subject to the same height and daylight plane regulations as the main dwelling

Accessory structures located in the required setback.....

- May not be located in the front yard
- May not be located in the street-side yard
- May not be located in the rear yard of a through lot
- May not cover more than 50% of the rear yard
- May not be used for sleeping or living
- Are subject to the accessory-structure height and daylight plane regulations (see Figs 25-26 on p. 32)
- May NOT have a kitchen
- Count toward the total lot coverage
- If over 120 sf, require a building permit and count towards total gross floor area
- If over 200 sf, may have no more than two plumbing fixtures

Examples of Accessory Structures

- Landscaping elements e.g., gazebos and arbors
- Mechanical equipment e.g., air conditioning units, pool equipment, and generators
- Play structures e.g., basketball hoops and play houses
- Offices and studios including pre-fabricated ones
- Permanent BBQs and fireplaces
- Garages
- Potting sheds, green houses, storage sheds etc.

Note: Accessory structures less than 120 sf do not require a building permit but must still comply with all zoning regulations

Accessory structures site planning

Note: Site planning for accessory buildings differs from that for parking structures in one way. A special allowance enables garages to be located in the rear/side yards even when the lot is not deep enough to maintain the 75' minimum distance from the front lot line. This does not apply to non-parking accessory structures.

Fig 24 Examples of site planning solutions for accessory structures

A Combo garage /small pool cabana (side by side)

- Structure is located in rear yard so it must:
 - a. be at least 75' from the front lot line
 - b. be no more than 12' high
 - c. comply with accessory-structure daylight plane. (Figs 25 & 26 on p. 32)
- Structure is located right at the side lot line so that wall and the roof must be fire rated.
- Structure has 2 plumbing fixtures.

B Stand-alone pool cabana

- Structure is located in rear yard so it must:
 - a. be at least 75' from the front lot line
 - b. be no more than 12' high
 - c. comply with accessory-structure daylight plane. (Figs 25 & 26 on p. 32)
- Structure is located right at the rear lot line so that wall and the roof must be fire rated.
- Structure has 3 plumbing fixtures— sink, toilet, and shower and is greater than 200 sf, so it requires a CUP.

C Office above garage

- Structure is located within the buildable area, so it doesn't have to comply with regulations for structures in the required yards and it may be two stories high.
- Structure has 2 plumbing fixtures.
- Structure is new 2nd floor addition and therefore subject to the Planning Department's Individual Review (IR).

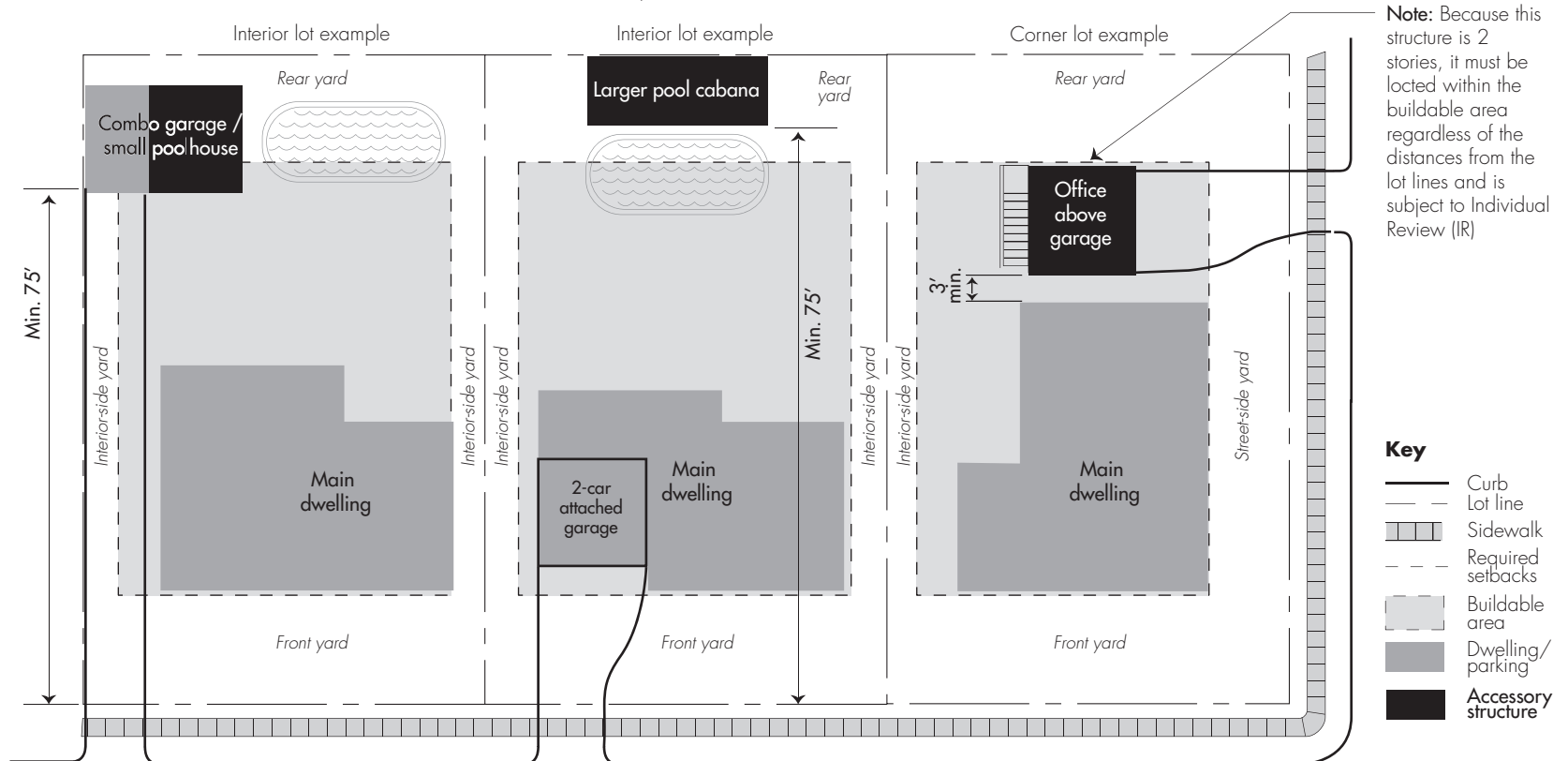

Accessory structure daylight plane (sides & rear)

The accessory structure daylight plane is much lower and regulates structures located in the rear/side yards.

Fig 25 Front elevation showing accessory-structure daylight plane at the side of the lot

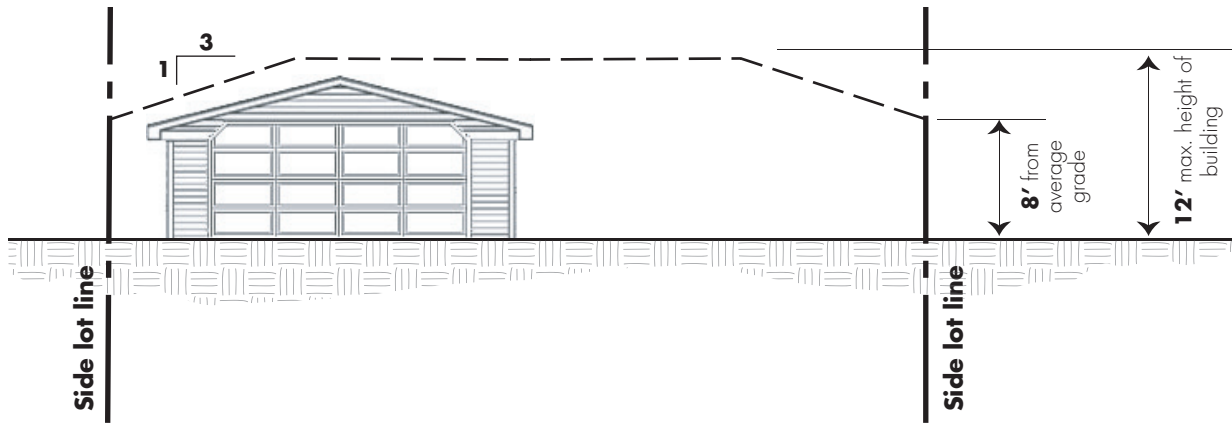

Note: For accessory buildings near the rear & side lot lines, a hipped-gable roof is often the best solution for complying with the accessory-structure daylight plane.

Fig 26 Side elevation showing accessory-structure daylight plane at the rear of the lot

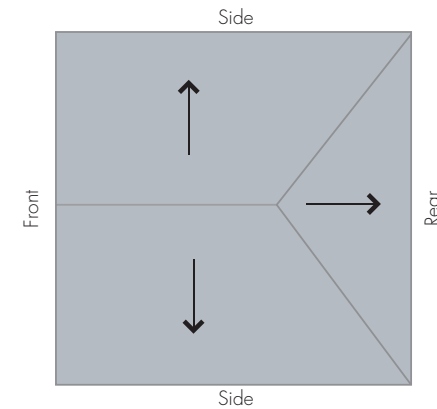
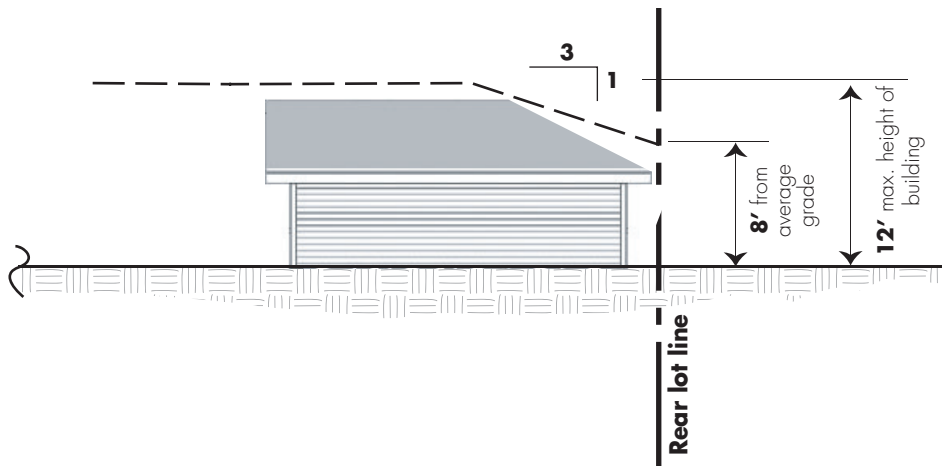

Noise-producing equipment site planning

- May not be located in front, rear, or interior-side yards.
- May encroach into street-side yard up to 6' (*Fig 27 C below*)
- All service equip. must meet the City's Noise Ordinance in Chapter 9.10 of the Municipal Code.
- Replacement of equipment shall conform to this section where feasible.
- Must be insulated and housed, however, Planning Dept. can waive this requirement if equipment is located in buildable area and a combination of noise specifications, location, and/or other screening or buffering will assure compliance with the City's Noise Ordinance at the nearest lot line.

Fig 27 Examples of site planning solutions for noise-producing equipment

A Pool equipment

- Pool equip. is within buildable area even though there is room for it behind the garage/poolhouse in the required rear yard.
- Air conditioning equip. is located in an out-of-the-way niche maintaining the required 10' min. clearance for the driveway

B Pool equipment & AC unit

- Pool equip. is located within buildable area even though there is room for it next to the poolhouse in the required rear yard.
- Air conditioning equip. is located within buildable area behind the house. There is not enough room along the interior side of the house.

C Generator & AC unit

- Air conditioning equip. is located in street side yard in compliance with the regulations. Note that it may not encroach into the front or rear yards.
- Generator is located within buildable area.

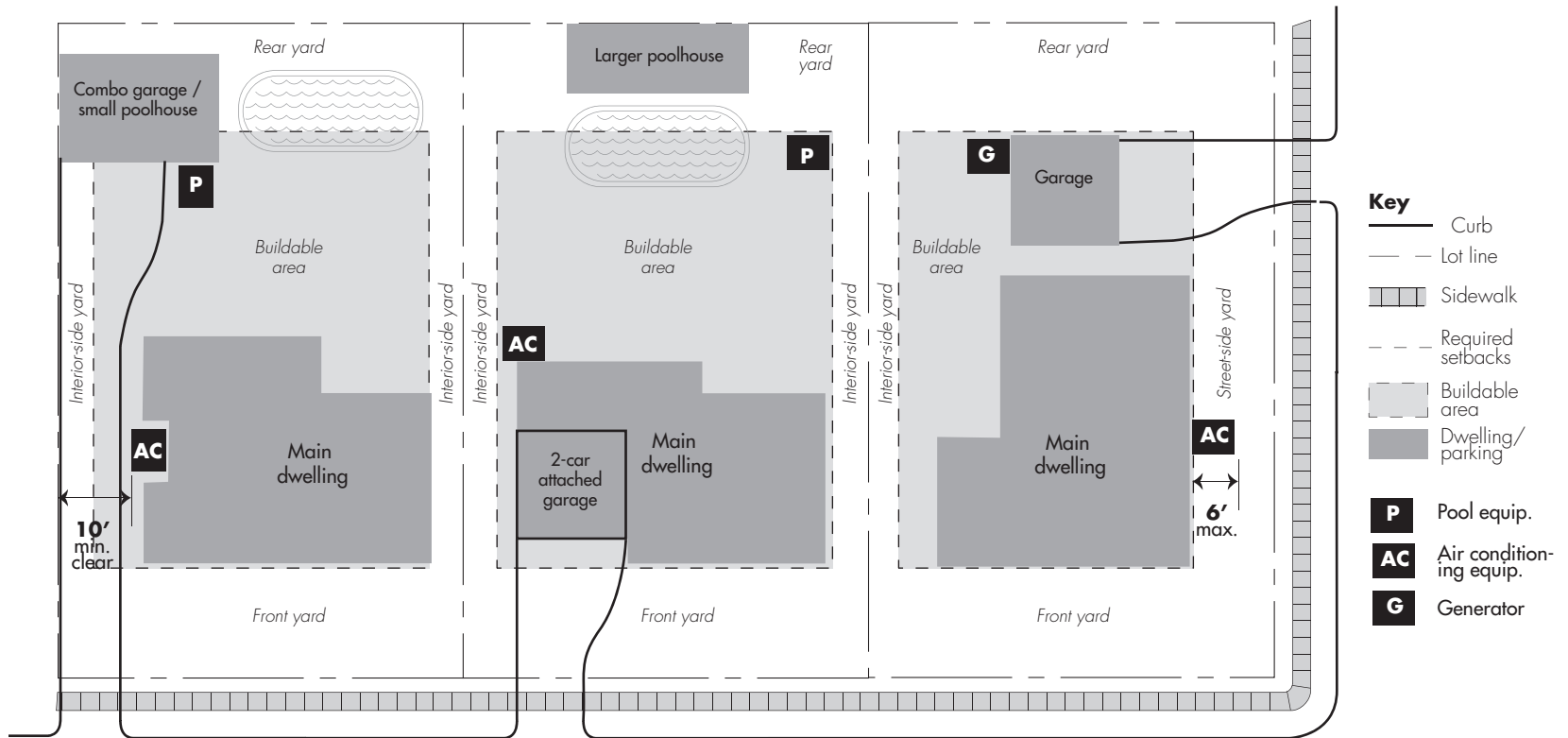

Parking

Parking regulations affect the appearance of the streetscapes in our residential neighborhoods by minimizing the number of cars parked on the street and in the front yards by requiring that there are parking spaces available deeper into the lot.

Code sections

Page 34

18.12.060, 18.83.090

Page 35

18.83.090, 18.83.110(a)

Page 36

18.12.060

Page 37

18.12.040 (f)

Page 38

18.12.060

Page 39

18.12.080 (b)

Parking space standards

- Two spaces are required on the lot (per dwelling).
- They may NOT be located in the required front yard or, first 10 ft of, required street side yard.
- 2nd dwelling units have same requirements.
- No underground parking garages except by variance.
- One of the two spaces must be covered.
- To be considered detached, a covered-parking structure must be a minimum of 3' from the main dwelling.
- Minimum size for an uncovered space is 8.5' x 18'.
- Minimum clearance inside a covered parking structure to be 10' x 20' for each space. Therefore, a two-car garage or carport to be 20' x 20' clear inside.
- Minimum vertical clearance: 7'.

* Clear area for parking space must be free of other uses e.g., water heaters, clothes washers or dryer, bicycle parking facilities, etc.

Fig 28 Parking space dimensions for garage and uncovered space in plan view

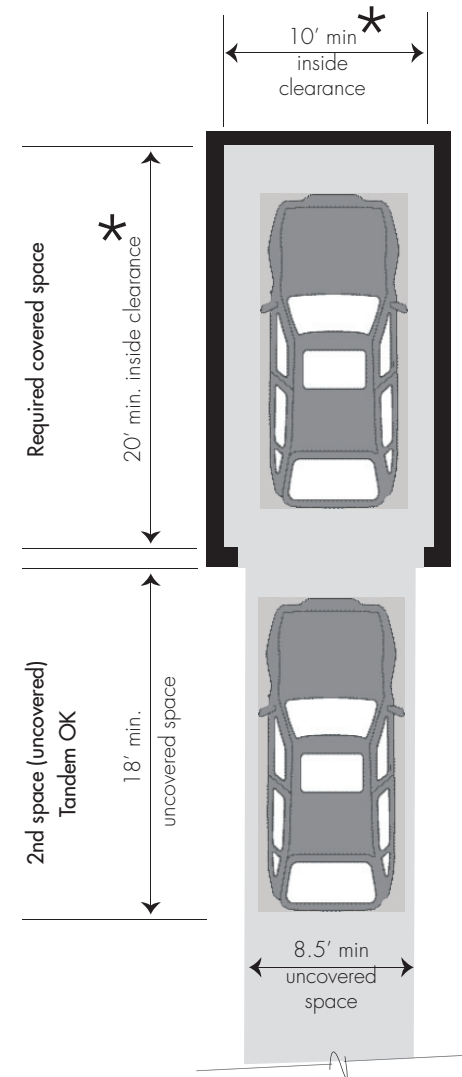

Carport standards

Both garages and carports count towards gross floor area. Carports are defined in the Municipal Code as having two open sides and do not have doors.

Fig 29 Parking space dimensions for carport in plan view

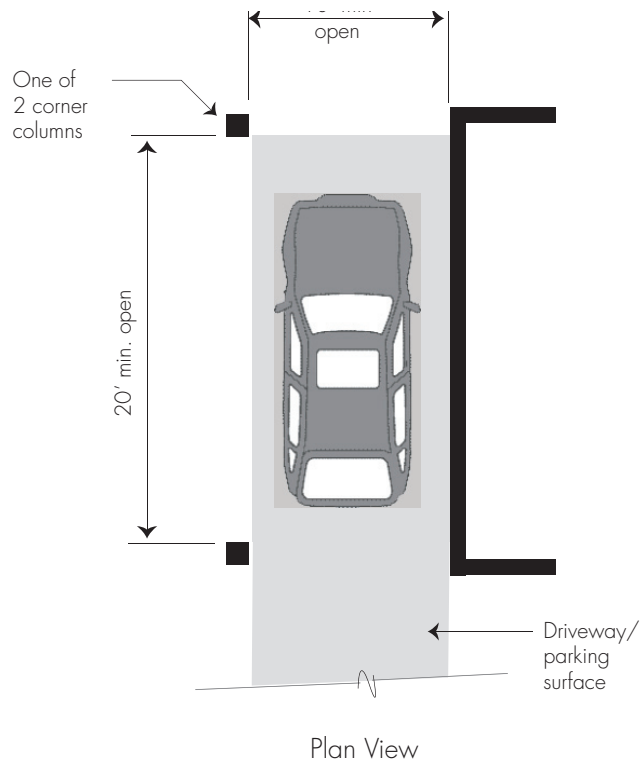
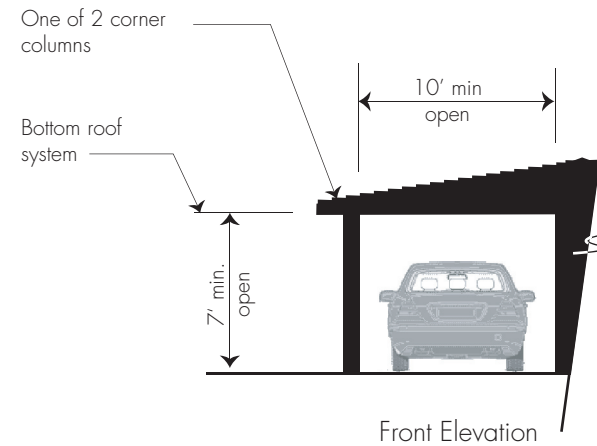
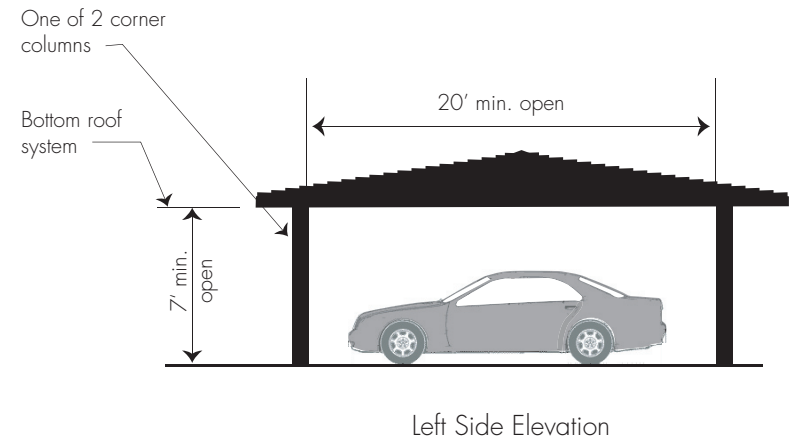

Fig 30 Parking space dimensions for covered space in elevation



Driveway standards

- Driveway surfaces may have either permeable or impermeable paving. Materials shall meet Public Works standards.
- Driveway surface within 10' of the public right-of-way may not be of a loose material e.g., gravel.
- 2nd dwelling units must share common driveway with main dwelling.
- Minimum driveway clearance: 10'
- Minimum driveway surface: 8'
- Minimum 20' between curb cuts.
- No more than 40% of required front yard may be impermeable.
- Street-work permit required for work done within the public right-of-way.

For safety reasons, the city also encourages that the following standard be met:

- No more than one curb cut per single frontage.
- Minimum of 50' between curb cut and intersection curb face.

Fig 31 Driveway standards

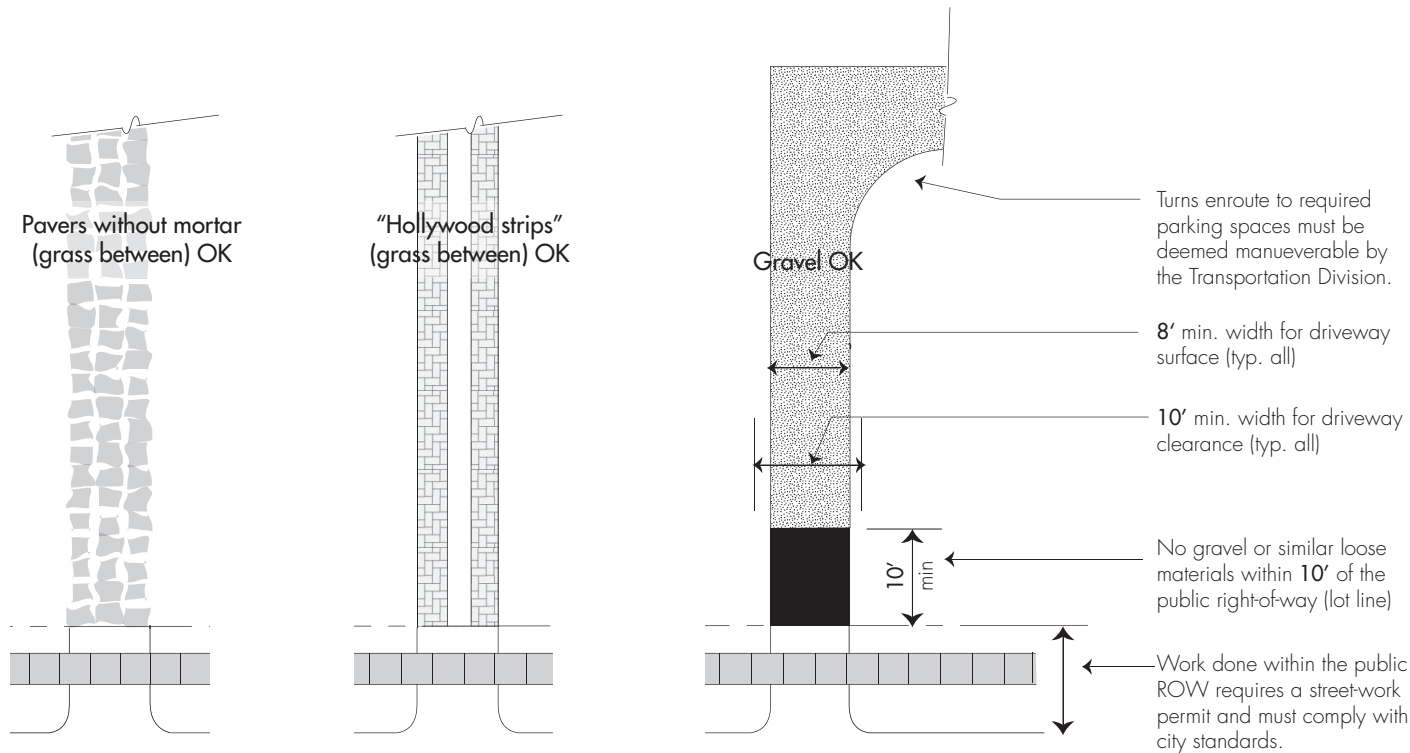

Contextual garage placement

Contextual garage placement applies if, and only if, there is a predominant neighborhood pattern.

How to determine if contextual garage placement applies (using Fig 32 below as an example)

Note:

- If block is more than 600' long, consider only lots within 600' or the 10 lots closest to the subject lot
- If subject lot is a corner lot, consider the pattern on the street that the subject garage faces

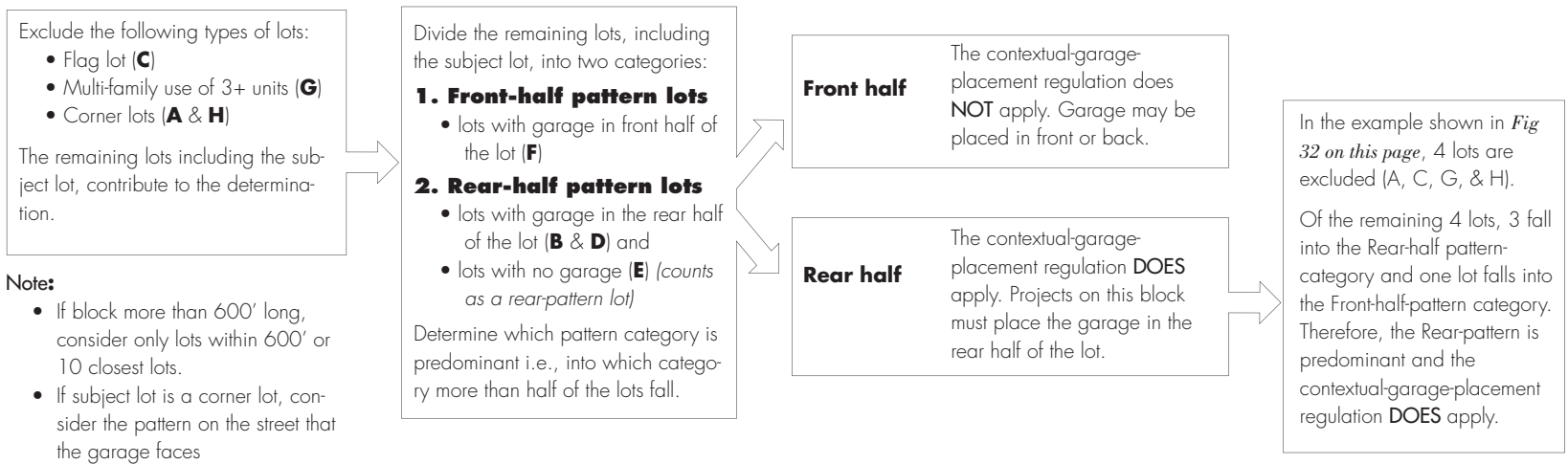
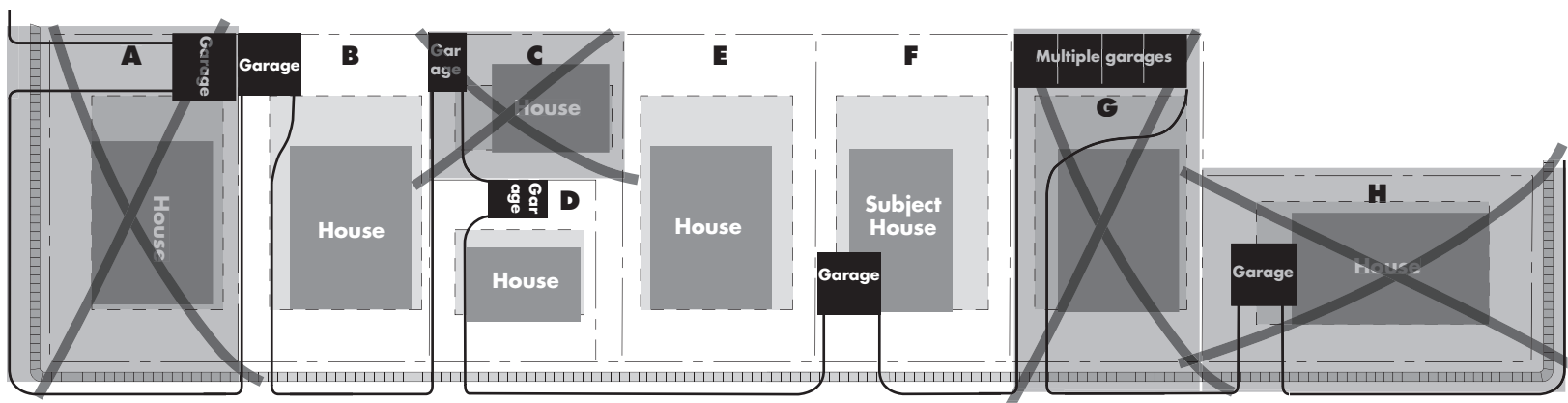

Fig 32 Example of a block on which the contextual garage placement regulation applies



Attached garages/carpports site planning

- Attached garages must comply with same setbacks as main dwelling.

Note: Uncovered spaces must be located beyond the required frontyard and beyond the first 10' of the street-side yard.

Fig 33 Examples of site planning solutions for attached garages/carpports

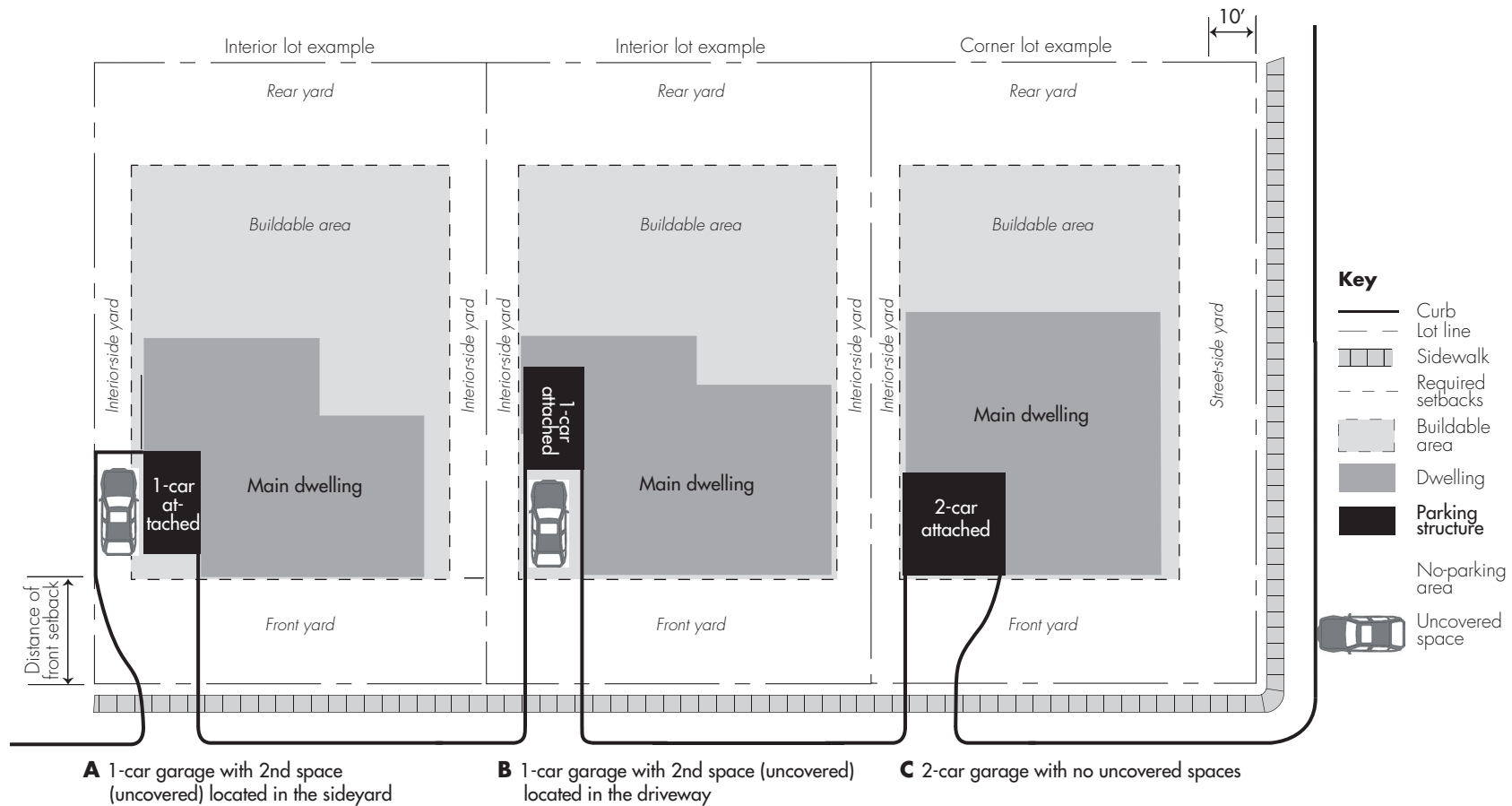

Detached garages/carports site planning

- Detached garages and carports may be located in the rear or interior side yard if at least 75' from the front lot line and at least 20' from the street-side lot line.
- Additionally, on lots less than 95' deep, they may be located in rear or interior side yards if placed in rear half of the lot.
- Garages and carports that take advantage of this setback exception are subject to a stricter daylight plane. See Figs 25-26 p. 32.

Note: Uncovered spaces must be located beyond the required front-yard and beyond the first 10' of the street-side yard.

Fig 34 Examples of site planning solutions for detached garages/carports

Note: In all the examples on this page, a 1-car garage could be substituted for a 2-car garage because there is room for uncovered parking in the driveway.

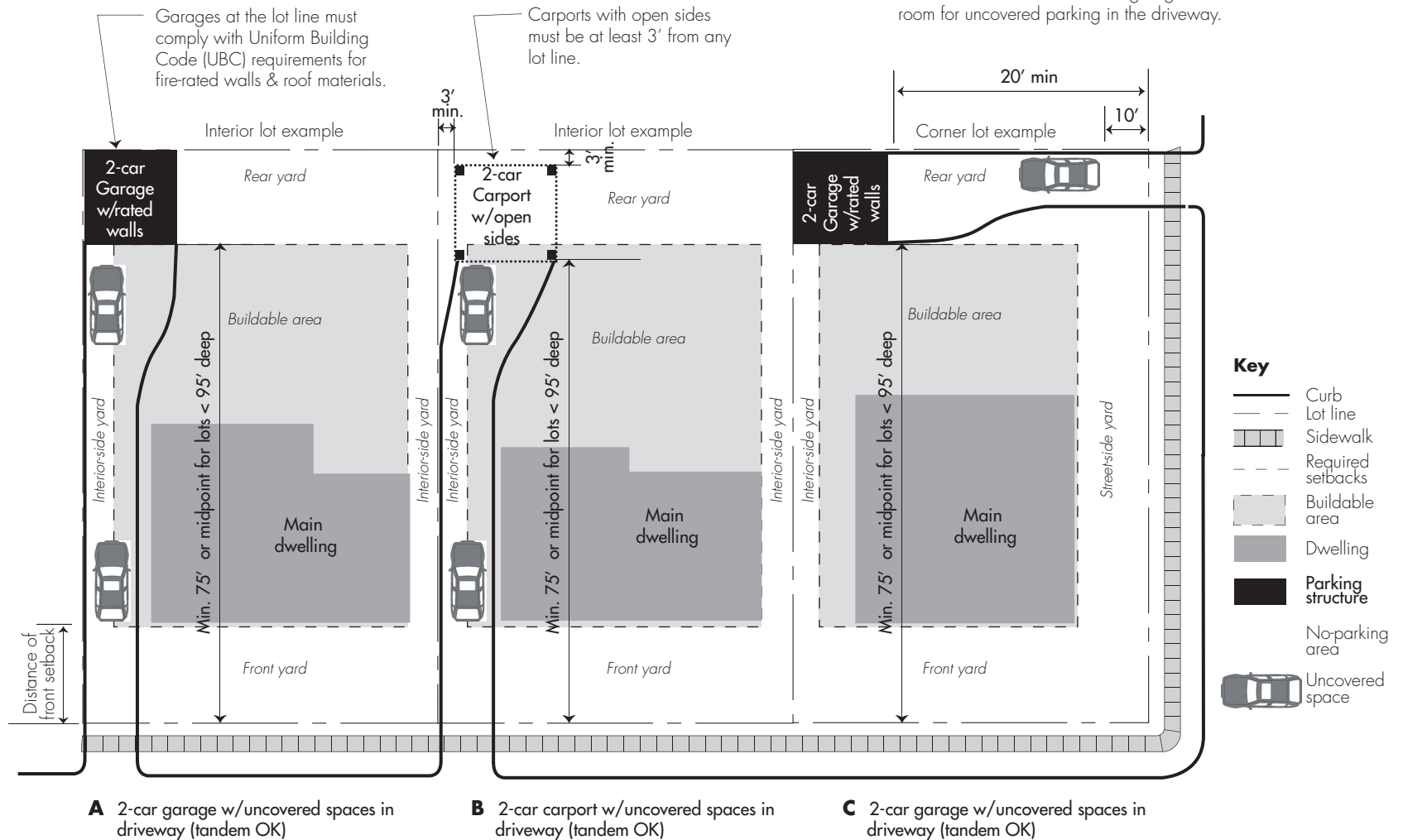

Basements & Excavated features

Floor area regulations are intended to address the building mass and the appearance of the streetscape. Therefore, if basement area is below grade and does not contribute to the apparent mass of a building, that area, even if it is habitable, need not be included in the total floor area.

Code sections
Page 40
18.12.090 (a, b, & c)
Page 41
18.12.090 (c)
Page 43
18.12.090 (c) (1)
Page 44
18.12.090 (c) (2)

Basement standards

- May not be located in special flood hazard areas.
- May not extend beyond building footprint.
- May not encroach into required yards, except where main dwelling is permitted to extend into rear yard.

FAR

Basements (even habitable ones) do not count as floor area if first floor is no more than 3' above grade.

Fig 35 Basement & grade

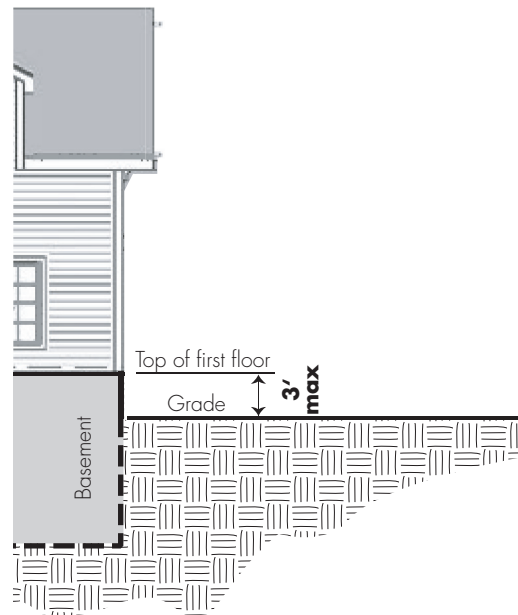

Excavated features

There are two types of excavated features:

- Light wells and stairwells
- Below-grade patios

FAR

Excavation will not affect grade or measurement of floor area if standards are met (see pages 42 and 43).

Fig 36 Excavated feature & grade

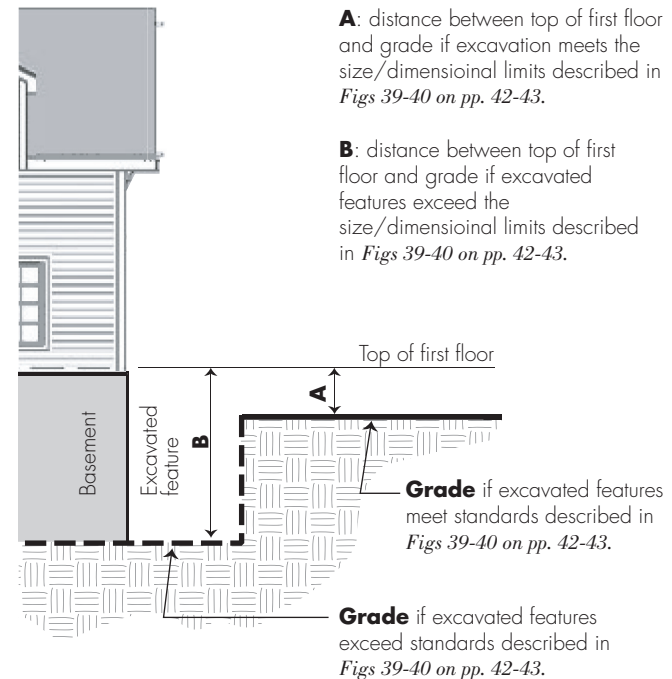

Other excavation considerations

Architectural compatibility & landscape screening

- If a guard rail is required, it must be designed to be architecturally compatible with the residence.
- Additionally, landscape screening may be required by the Planning Dept.

Tree protection

- A tree's root system extends well beyond the drip line and the roots are likely to be within the first 18" below grade.
- It is important to plan excavation in a manner that does not harm tree roots.
- Prior to issuance of building permit, owner to provide evidence that encroaching features or portions of features will not harm trees of any species on subject or abutting lots.
- Consult the city's Tree Technical Manual for other aspects of tree protection during construction.

Fig 37 Excavation, landscape screening, and guard rails

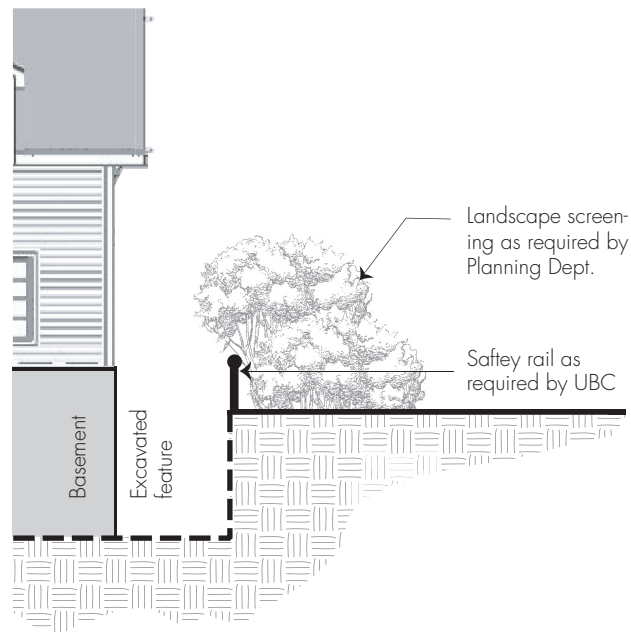
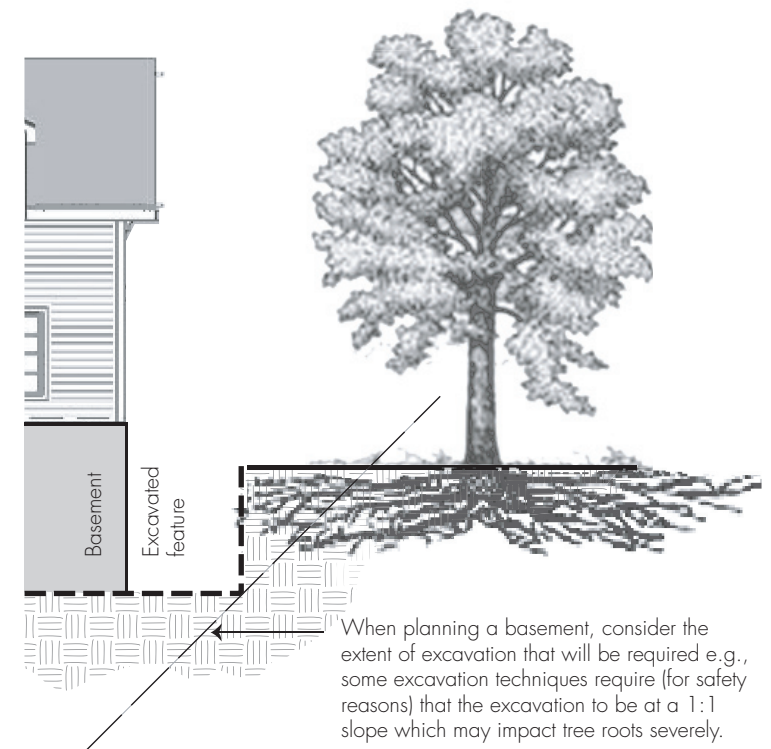

Fig 38 Excavation and tree roots



Light well & stairwell standards & site planning

Fig 39 Examples of site plan w/light wells & stairwells

- Such features may not be located on the side of the structure that faces the front yard.
- Maximum width (interior dimension) is 3'.
- The combined length (*interior dimensions of the opening excluding encasing structure*) of all the excavated features may not exceed 30% of basement perimeter.
- Allowable encroachment into required side yard is 3' max (however feature must be a minimum of 3' from side lot line).
- Allowable encroachment into required rear yard is 4'.
- The combined length (*interior dimensions of the opening excluding encasing structure*) of all the excavated features or portions of features that encroach into the required yards, on all sides of the structure, may not exceed 15'.
- Excavated features shall not be harmful to neighboring trees.
- Public Works Department must approve drainage system.

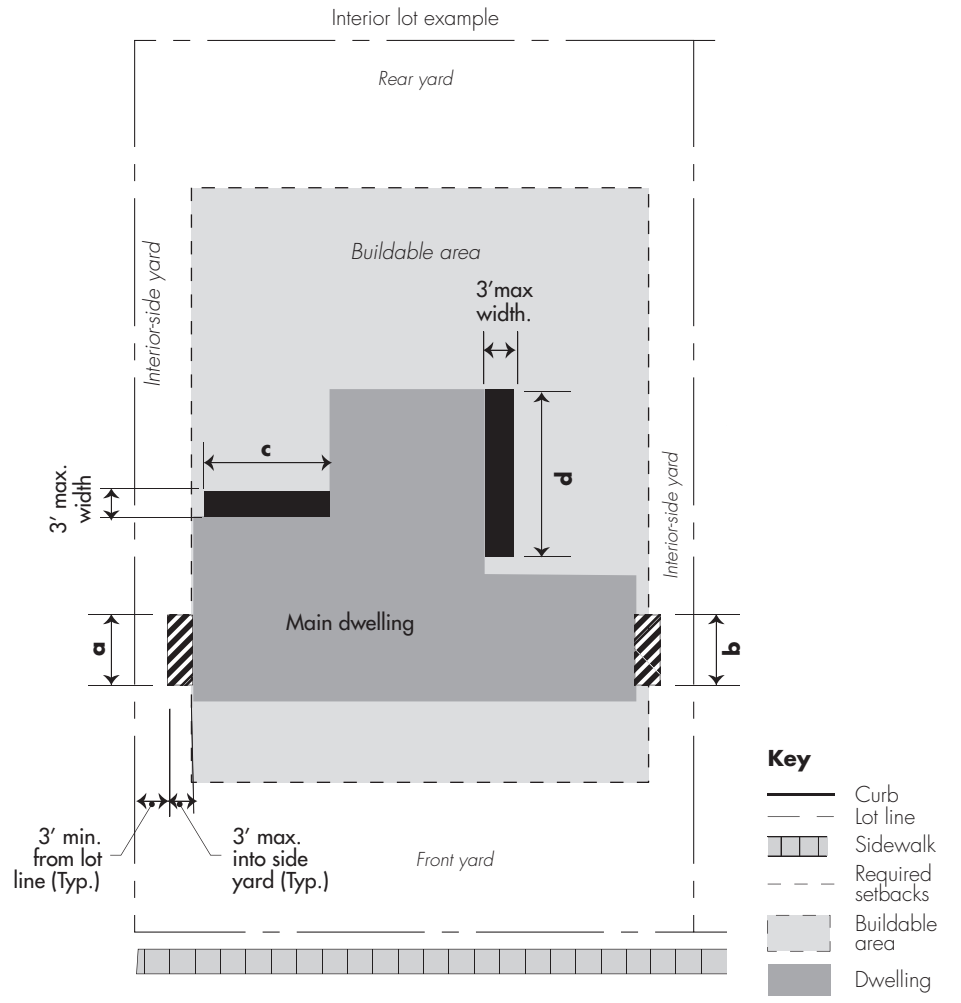

Lightwells & stairwells

- **a + b** (encroaching features) may not exceed 15'
- **a + b + c + d** (all features) may not exceed 30% of the perimeter of the basement

Note: measurements are based on interior dimension of opening and exclude encasing structure.

Below-grade patios standards & site planning

- Such features may not be located on the side of the structure that faces the front yard.
- Combined area of all such areas not to exceed 2% of the area of the lot or 200 sf, whichever is greater and no single area may exceed 200 sf. Note area devoted to required stairway egress shall not be included in the 200 sf limitation.
- Each such area is separated from another by at least 10'.
- Allowable encroachment into required side yard is 2' max.
- Allowable encroachment into required rear yard is 4'.
- The combined length of all the excavated features or portions of features that encroach into the required yards, on all sides of the structure, may not exceed 15'.
- Excavated features shall not be harmful to neighboring trees.
- Public Works Department must approve drainage system.
- Overhangs or canopies installed to shelter such area shall count towards lot coverage.
- Such areas to be architecturally compatible with residence.
- Such areas to be screened to off site views by means of landscaping and/or fencing as determined appropriate by Planning Dept.

Fig 40 Examples of site plan w/below-grade patios

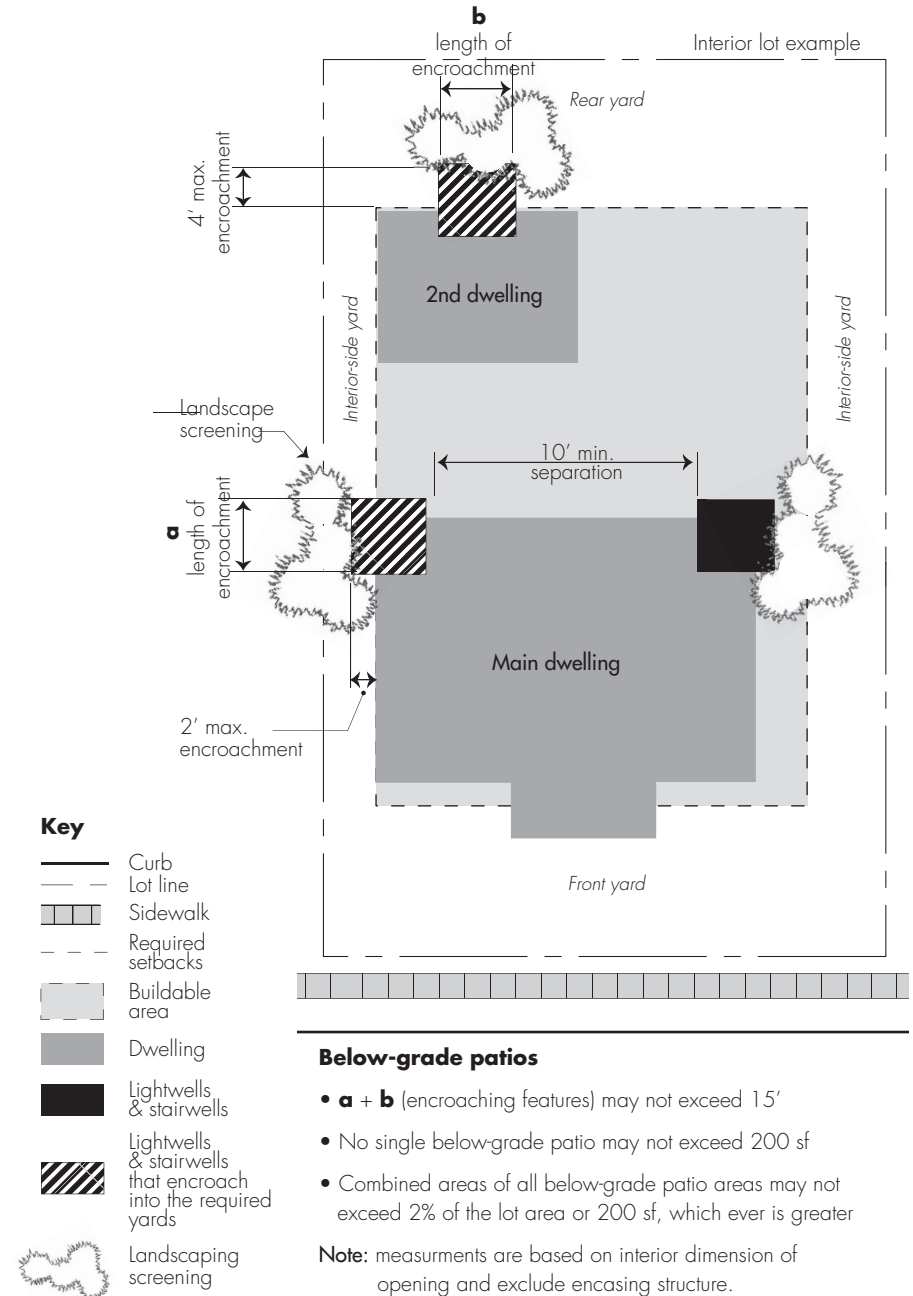

2nd dwelling units

Some lots are large enough to accommodate a 2nd dwelling unit and still maintain the low density that is appropriate for single-family neighborhoods. These units provide for a variety to the City's housing stock and additional affordable housing opportunities.

Code sections

Page 44

18.12.070 (b) (1 & 2)

Table 5

18.12.070 (c, d, e, & f)

Page 45

18.12.080 (d, e, & f)

2nd-dwelling units standards & site planning

Lots that meet the minimum size may have an attached or detached 2nd-dwelling unit that is a separate unit and is subordinate to the main dwelling. 2nd dwelling units must comply with all regulations applying to the main dwelling except as follows:

Attached units

- Lot size must meet minimum for zone. *(see table)*
- Maximum size is 450 sf *(basement area counts towards the size of the 2nd-dwelling unit even if it does not count toward total gross floor area.)*
- Maximum height is 17'.
- Must have two parking spaces (one to be covered).
- Maximum size for covered parking is 200 sf. *(This is in addition to the 450 sf allowed for the 2nd-dwelling unit.)*
- Except on corner lots, entrance way shall not face same lot line as entrance to main dwelling.
- Exterior staircases to 2nd floor units shall be located toward interior side or rear yard.
- Must be located within the setbacks just like the main dwelling. *(Fig 41 on p. 45)*
- Counts towards total FAR for the lot

Detached units *(Fig 41 A-D on p. 45)*

- Lot size must meet minimum for zone *(see table)*
- Maximum size is 900 sf *(basement area counts towards the size of the 2nd-dwelling unit even if it does not count toward total gross floor area.)*
- Maximum height is one story and 17'
- Must share driveway with main dwelling
- Must have two parking spaces (one to be covered)
- Maximum size for covered parking is 200 sf. *(This is in addition to the 900 sf allowed for the 2nd-dwelling unit.)*
- Must be architecturally compatible with main dwelling.
- Must be located 12' from the main dwelling.
- Must be located within the setbacks just like the main dwelling. *(Fig 41 on p. 45)*
- Counts towards total FAR for the lot

Min. lot size for 2nd dwelling unit by zone

Zone District	Typical lot	Flag lot
R-1	8,100 sf	9,720 sf
R-1(7000)	9,450 sf	11,340 sf
R-1(8000)	10,800 sf	12,960 sf
R-1(10000)	13,500 sf	16,200 sf
R-1(20000)	27,000 sf	32,400 sf

Parking for 2nd dwelling units

is treated the same as parking for the main residence. See "Site planning for attached garages/carports" and "Site planning for detached garages/carports" in the "Parking" section of this manual.

Note that parking for the 2nd dwelling unit may be combined with parking for the main residence e.g., a two-car garage as shown in *Fig 23 C & D*.

Detached 2nd-dwelling units & associated parking site planning

Fig 41 Examples of site planning solutions for detached 2nd dwelling units and associated required parking

A Detached & separate from main-dwelling parking

- Main dwelling has a 1-car attached garage.
- 2nd dwelling has a 1-car detached garage. (Because it is detached and at least 75' from the front lot line, it may be located in the rear and side yards.)
- Both dwellings use driveway for their uncovered spaces (beyond front setback)

Interior lot example

B Attached & separate from main-dwelling parking

- Main dwelling has 1-car attached garage.
- 2nd dwelling has a 1-car attached garage. (Because attached, it must be located with the building area rather than in the rear or side yards.)
- Both dwellings use driveway for their uncovered spaces (beyond front setback)

Interior lot example

C Detached & combined with main-dwelling parking

- Both dwellings share a 2-car detached garage. (Because it is detached and at least 75' from the front lot line, it may be located in the rear and side yards.)
- Both dwellings use the driveway for their respective uncovered spaces (beyond front setback)

Interior lot example

D Combined w/ main-dwelling parking that is attached to main dwelling

- Both dwellings share a 2-car attached garage.
- Both dwellings use the driveway for their respective uncovered spaces (beyond front setback)

Interior lot example

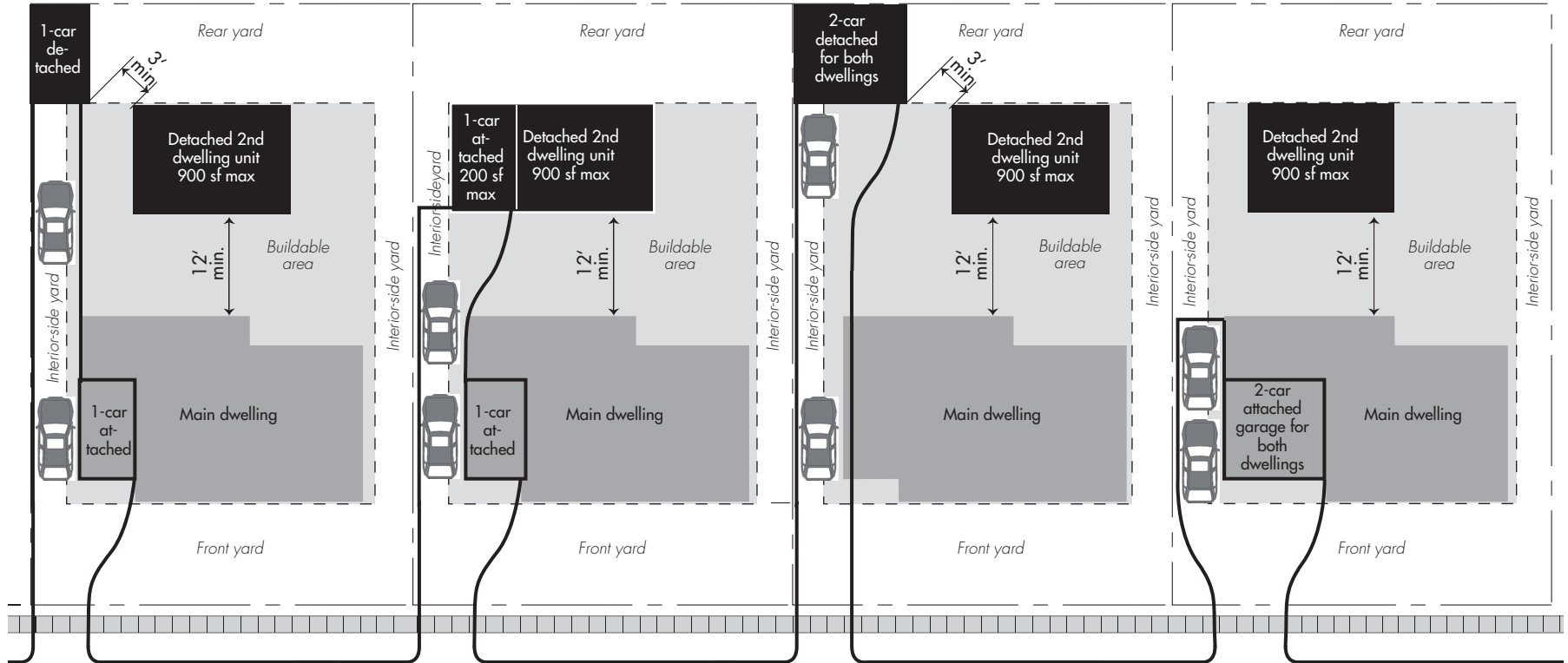

Key

- Curb
- - - Lot line
- ▤ Sidewalk
- - - Required setbacks
- ▨ Buildable area
- Dwelling
- 2nd-dwelling unit & associated pkg
- Area that may not be used to satisfy required parking spaces
- 🚗 Uncovered space

Height & grade

Height allowances enable a variety of architectural styles while preserving the residential scale of our neighborhoods as well as the privacy and natural light available to each lot.

Code sections
Page 46
 18.12.040 (a) Table 2
Page 47
 18.04.030 (64) (b)

Height

Structure	Max. height to roof peak
Main dwelling on a standard lot with a roof slope <12:12	30'
Main dwelling on a standard lot with a roof slope ≥12:12	33'
Main dwelling on a substandard or flag lot	17'
Accessory structure in rear or side yard	12'
2nd-dwelling units	17'

Fig 43 Determining slope of roof

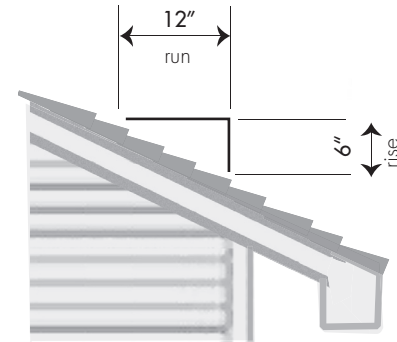

Roof slope is the vertical rise in inches for every horizontal distance of twelve inches (called the "run"). It is expressed as rise:run or, in this example 6:12.

Note: On a drawing this slope might also be represented as:

$$6 \left| \begin{array}{l} 12 \\ \hline \end{array} \right. \quad \text{or} \quad 1 \left| \begin{array}{l} 2 \\ \hline \end{array} \right.$$

Fig 42 Comparison of roof slopes

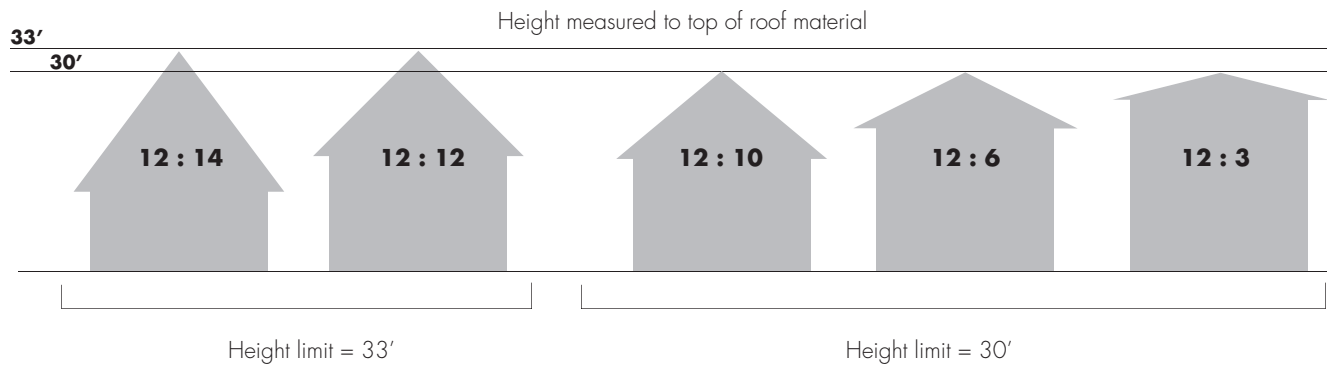

Grade

When measuring	Use	Which is defined as	Illus.
The height of a structure on land with natural slope $\leq 10\%$	Existing Grade	for each building or structure, the lowest point of adjacent ground elevation prior to grading or fill	Fig 44 on this page
The height of a structure on land with natural slope $> 10\%$	Grade	adjacent ground elevation of the finished or existing grade, whichever is lower-- at any point of the structure	Fig 45 on this page
A daylight plane	Average grade	average of the grade at the midpoint of the building and the grade at the closest point on the abutting site	Figs 20-21 pp. 26-27

Fig 44 Existing vs. Finished grade

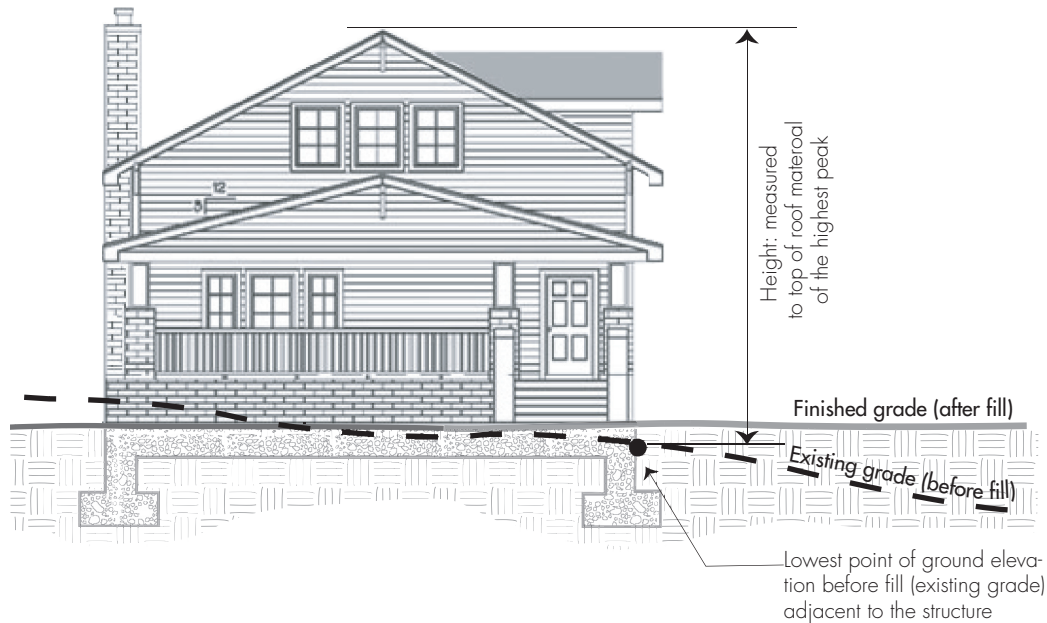

Fig 45 Height limits for structures on slopes greater than 10%

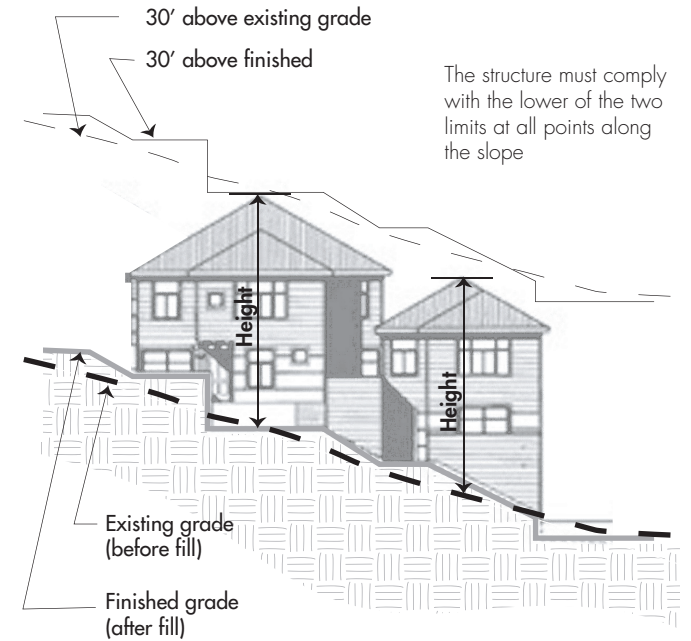
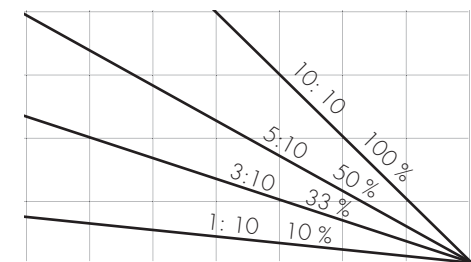

Fig 46 Comparison of different grades





I want it to be
portrait.



I want it to be like the
old Book.

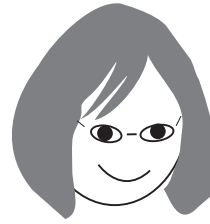

I want it to be a
coloring book.



I want to know
when it's due.



Whatever you
want.

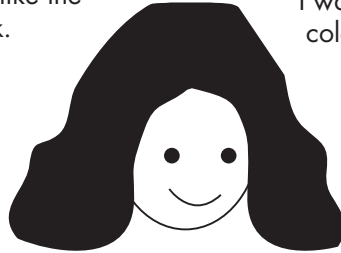

I want it to be
alphabetical.



Street...hyphen...side.
..space...yard

Prepared by:

Gloria Humble, Advance Planning

Project Team:

John Lusardi, Special Projects Manager

Clare Campbell, Special Projects

Sue Mickelsen, Special Projects

Amy French, Current Planning Manager

Gina La Torre, Current Planning

Russ Reich, Current Planning

Paul Mennega, Current Planning

Special Thanks to:

Arnold Mammarella of Origins Design Network