

Mosaic Analysis in the *Drosophila* Ovary Reveals a Common Hedgehog-Inducible Precursor Stage for Stalk and Polar Cells

Michael Tworoger, Michele Keller Larkin, Zev Bryant and Hannele Ruohola-Baker

Department of Biochemistry, University of Washington, Seattle, Washington 98195-7350

Manuscript received July 8, 1998

Accepted for publication November 4, 1998

ABSTRACT

The fates of two small subgroups of the ovarian follicle cells appear to be linked: mutations in *Notch*, *Delta*, *fs(1)Yb*, or *hedgehog* cause simultaneous defects in the specification of stalk cells and polar cells. Both of these subgroups are determined in the germarium, and both cease division early in oogenesis. To test the possibility that these subgroups are related by lineage, we generated dominantly marked mitotic clones in ovaries. Small, restricted clones in stalk cells and polar cells were found adjacent to each other at a frequency much too high to be explained by independent induction. We therefore propose a model in which stalk cells and polar cells are derived from a precursor population that is distinct from the precursors for other follicle cells. We support and extend this model by characterization of mutants that affect stalk and polar cell formation. We find that ectopic expression of Hedgehog can induce both polar and stalk cell fate, presumably by acting on the precursor stage. In contrast, we find that *stall* affects neither the induction of the precursors nor the decision between the stalk cell and polar cell fate but, rather, some later differentiation step of stalk cells. In addition, we show that ectopic polar and stalk cells disturb the anterior-posterior polarity of the underlying oocyte.

THE differentiation of specialized cell types can be governed both by external signals and intrinsic differences resulting from asymmetric cell divisions. Unraveling how the complex interplay of extrinsic and intrinsic factors determines cell fates is a challenging problem in developmental biology (for a recent review see Jan and Jan 1998). In some tissues, for example, the *Drosophila* ommatidia, where the cells are not related by lineage, cell fates are determined entirely by external cues in the form of cell-cell signaling pathways (Becker 1957; Wolff and Ready 1993). In contrast, yeast mother-daughter cell differentiation does not rely on external stimuli, but it is attributable to asymmetric division that leads to asymmetric partitioning of the Ash1 protein and, therefore, asymmetric expression of HO endonuclease (Bobola *et al.* 1996; Sil and Herskowitz 1996). In some cases, such as *Drosophila* neuroblasts, which are lineage related, both internal and external cues are used (reviewed in Gho and Schweisguth 1998; Jan and Jan 1998). Asymmetric segregation of Numb protein during cell division leads to inactivation of Notch receptor in one of the daughter cells.

In the *Drosophila* ovary, the germline is surrounded by a somatic follicle cell layer, and signaling from this layer plays a key role in oocyte development. In particular, patterning of the follicle cell layer generates positional information that is transferred to the developing

oocyte via signaling pathways, and that is instrumental for establishment of embryonic polarity. Therefore, it is pivotal to understand the patterning of the follicle cell layer. Early in oogenesis, the dividing somatic cells are largely undifferentiated and provide an excellent system in which to study cell fate decisions. It has been shown that cell-cell communication plays a major role in follicle cell differentiation (reviewed in Ray and Schüpbach 1996; Rongo and Lehmann 1996). Mosaic analysis has shown that most specialized subgroups of follicle cells are not restricted by lineage (Margolis and Spradling 1995).

Two small subgroups of follicle cells have been central to several genetic investigations: the polar cells and the stalk cells. Polar cells are sets of follicle cells located at the anterior and posterior tips of an egg chamber; stalk cells are a linear group of follicle cells that separate the egg chambers (Figure 1). Differentiation of these subgroups occurs when follicle cell intercalation separates egg chambers from the germarium, where germ line division takes place. Mutations in *hedgehog* (*hh*), *Notch* (*N*), *Delta* (*DI*), or *fs(1)Yb* cause defects in the specification of stalk and polar cell number (Ruohola *et al.* 1991; Xu *et al.* 1992; Bender *et al.* 1993; Johnson *et al.* 1995; Forbes *et al.* 1996a,b; Larkin *et al.* 1996). *daughterless* (*da*) and *toucan* (*toc*) are also involved in this process; however, their effect on both stalk and polar cell fates remains to be characterized (Cummings and Cronmiller 1994; Grammont *et al.* 1997). Models for differentiation of the stalk and polar cell subgroups have been generated on the basis of genetic data (Ruohola *et*

Corresponding author: Hannele Ruohola-Baker, Department of Biochemistry, Box 357350, University of Washington, HSB J-581, 1959 Pacific St., Seattle, WA 98195. E-mail: hannele@u.washington.edu

al. 1991; Johnson *et al.* 1995; Larkin *et al.* 1996). These models imply a lineage relationship between the two subgroups and suggest that some of the asymmetric differentiation cues might be intrinsic. However, the lineage relationship between these subgroups has not been tested.

Stalk cells and polar cells are determined in the germarium. Previous clonal analysis showed that polar cells stop dividing in the germarium long before the rest of the follicle cells surrounding the egg chamber (Margolis and Spradling 1995). Here we confirm this result and further show that stalk cells cease division early in oogenesis. To test the possibility that stalk and polar cells are related by lineage, we generated dominantly marked mitotic clones in ovaries. Small, restricted clones in stalk cells and polar cells were found adjacent to each other at a frequency much too high to be explained by independent induction. We, therefore, propose a model in which stalk cells and polar cells are derived from a precursor population that is distinct from precursors for other follicle cells. We support and extend this model by characterization of mutants that affect stalk and polar cell formation.

MATERIALS AND METHODS

Fly stocks: All lines were maintained at room temperature on standard cornmeal and molasses agar medium with dry yeast added. The following mutant alleles of *stall* were used in this study: *WU40*, *AWK26*, *PA49*, and *PH57* (Schüpbach and Wieschaus 1991). The *aTub84BFRTy+FRThh* line was a generous gift from G. Struhl. The enhancer trap lines *10613* and *10475* mark inner sheath cells and are insertions in the 5' end of the *patched* gene (Margolis and Spradling 1995; T. Mahowald, personal communication); *A101* marks polar cells. *93F* and *I(3)1344* mark stalk cells (Ruohola *et al.* 1991; Forbes *et al.* 1996a; Larkin *et al.* 1996; Zaffran *et al.* 1997). *GAI4(127)* marks terminal filament cells when used to drive the *UAS-lacZ* reporter gene. Kin:βgal line KL-32 (Clark *et al.* 1994) was used. The lines *y-w*; *x-15-33*, *y+/Cyo*, *y-w*; *x-15-29*, *w+/Cyo* and *hsFLP*, *Mkrs/nkd* were generated by Harrison (Harrison and Perrimon 1993) and were a gift from J. Margolis. *x-15-33* and *x-15-29* are the lines that carry the *FRT* sites, arranged as depicted in Figure 1. These lines were crossed to generate *y-w*; *x-15-33*, *y+/x-15-29*, *w⁺*; *hsFLP*, *MKRS/+* flies for clone induction.

Heat shocks: To induce mitotic recombination, 1- to 4-day-old adult *y-w*; *x-15-33*, *y+/x-15-29*, *w⁺*; *hsFLP*, *MKRS/+* females were placed on wet yeast for 1 day and then subjected to a 1-hr heat shock at 37° in a circulating water bath. Afterward, the flies were maintained at 25° and turned over onto fresh yeast daily. Flies were allowed to develop for 2 days and were then dissected in 1× PBS.

A previous study using this system in follicle cells (Margolis and Spradling 1995) found that clone induction was limited to a short time after heat shock. Additionally, the heat shock itself did not cause noticeable developmental arrest in ovaries, and the labeling frequency was approximately constant throughout oogenesis. Thus, this *Fdp/Frt* system has proven to be a well-behaved tool for the clonal analysis of follicle cells. Furthermore, β-galactosidase expression in recombinant clones is suitable for the analysis of stalk and polar cell subgroups.

To induce Hedgehog expression, *HS-FLP*; *αTub84BFRTy+FRThh* females were heat shocked for 15 min at 39° or 30 min at 37°. Fdpase activity places the *hh* gene downstream of the *αTub* promoter, permitting persistent, ectopic expression of *hh*. Flies were allowed to develop 24, 48, or 72 hr at room temperature before dissection. Receipt of the Hh signal was followed by *patched* (*ptc*) enhancer trap lines.

Staining and visualization: Immunocytochemistry, X-gal stainings, and light and confocal microscopy were carried out as described in Larkin *et al.* (1996), with the following exception: after x-gal staining, ovaries were postfixed for 15 min in 2% glutaraldehyde in 1× PBS.

For chromosome visualization by 4',6-diamidino-2-phenylindole (DAPI) staining, ovaries were dissected and fixed for 1 hr in 4% paraformaldehyde. After rinsing in PBS, ovaries were incubated in 0.01 mg/ml DAPI in PBS for 2 min. They were then rinsed and mounted on 70% glycerol slides. Propidium iodide (PI) chromosome staining was performed in the same manner, with the addition of a 30-min incubation in 0.5 mg/ml RNase (Sigma, St. Louis) in PBS, followed by a 10-min incubation in 1 mg/ml PI.

Calculations: The units counted in these experiments cover the posterior end of the earlier egg chamber, connecting stalk cells and the anterior end of the older egg chamber [(polar cells-stalk cells-polar cells (PC-SC-PC)]. Each stage 6 egg chamber contains two units. An alternative unit could be considered as the stalk and polar cell subgroups on opposite sides of the stage 6 egg chamber (SC-PC-(egg chamber)-PC-SC). However, the former definition of a unit is supported by the fact that coincident clones occurred 24 times in our experiments. In contrast, only five coincident clones occurred in sc or pc subgroups on opposite sides of stage 6 egg chambers in the same experiments.

We used the chi-square test in our analysis of stalk and polar cell correlation (for review see Taylor 1997). This analysis approximates how observed data relate to the expected outcome of the experiment. In the mosaic clone experiment, the observed data are the number of times stalk and polar cell clones occur separately *vs.* together; the expected outcome is predicted from independent induction of clones (see Tables 2 and 3). Because the chi-square is an approximate test, we verified the results of the chi-square test using Fischer's exact test. We obtained a value of <0.001 for the former and 1×10^{-16} for the latter, indicating the *P* value obtained by both methods is highly significant.

RESULTS

Stalk cells and polar cells cease dividing in the germarium: The *Drosophila* ovary is composed of ~15 ovarioles. Each ovariole consists of two major parts, the germarium and the vitellarium. The germarium is located at the anterior tip of the ovariole, and it contains stem cells for both germline and somatic cells. A germline stem cell divides to produce a daughter cell, which undergoes four rounds of division in region 1 of the germarium to form a 16-cell germline cyst, which is enveloped in region 2b (see Figure 1B) by a layer of somatic follicle cells. An egg chamber is formed when somatic cells anterior to the cyst in region 3 of the germarium intercalate to form a mature stalk consisting of five to seven specialized stalk cells (reviewed by King 1970; Spradling 1993) that separate adjacent egg chambers. Polar cells are located at the anterior and posterior poles of egg cham-

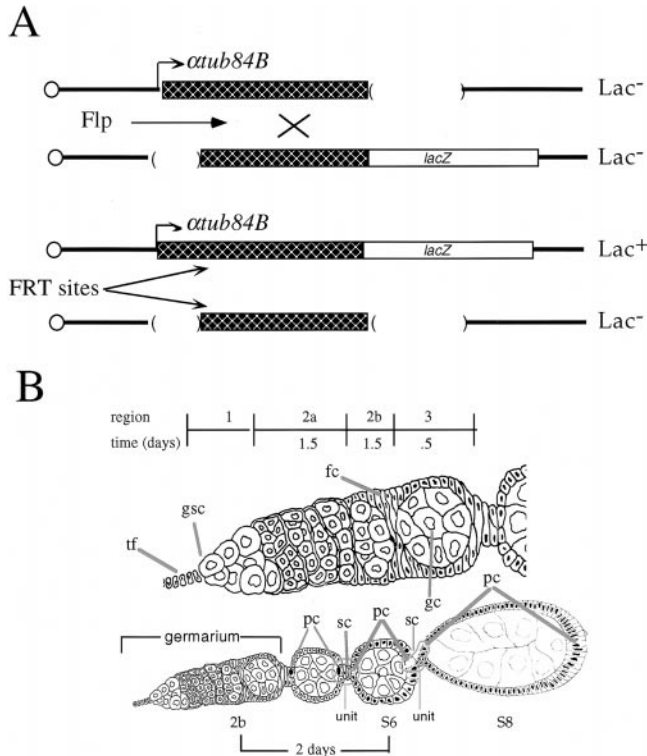
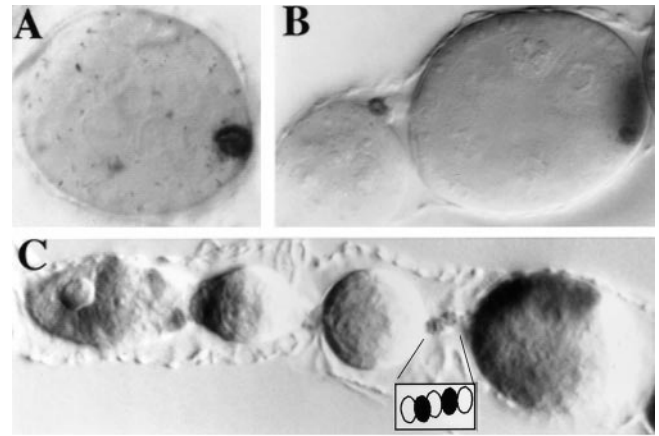

Figure 1.—(A) The system used to mark mitotic clones (adapted from Margolis and Spradling 1995). The *lacZ* gene is constitutively driven by the tubulin promoter because of an FLP-induced recombination event. The daughter cell that inherits the recombinant construct is dominantly marked, as are its progeny. (B) The time scale for different developmental steps in oogenesis. tf, terminal filament cells; gsc, germline stem cells; fc, follicle cells; gc, germline cells; sc, stalk cells; pc, polar cells; S6 and S8, stages 6 and 8 of oogenesis. Unit is a PC-SC-PC unit on each side of a stage 6 oocyte.

bers and have a round morphology distinct from that of the columnar follicle cells (Brower *et al.* 1981; Ruohola-Baker *et al.* 1994). The statement “early oogenesis” in this study includes stages from the germarium to stage 6 of oogenesis.

Previous work has demonstrated by clonal analysis that polar cells cease division in the germarium (Margolis and Spradling 1995). No such direct evidence has been shown for stalk cell divisions, although stalk cell morphology strongly suggests that these cells cease division early in oogenesis. To address this question, we used the *FLP/FRT* system (Golic 1991) modified by Harrison and Perrimon (1993) to induce clones in mitotic cells. This system uses a heat shock promoter to drive transcription of the FLPase protein, which catalyzes recombination specifically between *FRT* sites in mitotic chromosomes. Recombination places the *lacZ* gene downstream of an α 84BTubulin promoter, thus dominantly and persistently marking the target cell and its progeny (Figure 1A). This system has previously been shown to exhibit no background recombination in the absence of heat shock, and to induce mitotic recombina-



D Frequency a mosaic cell occurs in clone size=x

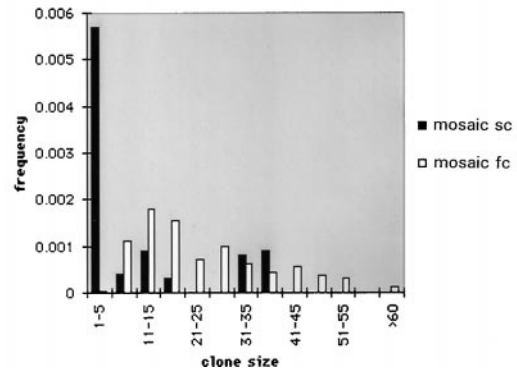

Figure 2.—Stalk cells and polar cells cease dividing early. Small clones (on average two cells) were detected in polar cells (A) and stalk cells (B and C) at a much higher frequency than in the main body follicle cells (D), suggesting that sc and pc subgroups ceased division early in oogenesis. The few extremely large clones (>60) detected in the main body follicle cells may result from multiple clones existing in close proximity. We also analyzed the frequency of small clones in the main body follicle cells as an indication of the amount of residual FLP activity after heat shock. If the extremely small clones in stalk and polar cell groups were attributable to residual FLPase, they should have occurred with approximately the same frequency, on a per cell basis, as small clones in the main body follicle cells. However, the frequency of small clones in main body follicle cells was 124 times lower than the frequency detected in the stalks, suggesting that the small clones detected in the stalks are due to early cessation of cell division and not to late induction via FLPase activity.

tion only in actively cycling cells (Harrison and Perrimon 1993; Margolis and Spradling 1995).

We analyzed the behavior of stalk cells and polar cells by examining ovaries dissected 2 days after heat shock and scoring clones in stage 6 egg chambers and their flanking stalks. We chose stage 6 because it is the most mature stage around which stalks are frequently visible. According to previously reported timing of oogenic stages (King 1970; Spradling 1993), the progenitors of the clones we scored were in region 2b of the germarium (Figure 1B) at the time of FLP-induced recombination. Because approximately five rounds of division occur

TABLE 1
Clone data and calculations

Item	Value	Calculation
Days AHS	2	—
Position at HS	Region 2a/2b	—
Clone frequency	1.5	443 clones/288 chambers ^a
Clone size	14.1	6243 cells/443 clones
Rounds of division AHS	4.8	1 + log(clone size)/log 2
Follicle cells/chamber at HS	23.0	651/2 ^{4.8}
Labeling frequency	7.0%	Clone freq./ (cells/chamber)

AHS, after heat shock.

^a Seventy-two percent of these egg chambers contained at least one clone.

between region 2b and the end of stage 6 (Margolis and Spradling 1995), we expected to observe follicle cell clones of ~16 cells in size. Significantly smaller clones should only appear in groups of follicle cells that cease dividing in the early stages of oogenesis. In keeping with our expectations, the average clone size in stage 6 follicles was 14.1 cells (Table 1). Smaller clones (approximately two cells) were primarily restricted to both putative polar and stalk cells (Table 2; Figure 2D), indicating that both of these groups cease division during or shortly after region 2b of the germarium, the calculated time of heat shock.

Stalk cells stop dividing late in the germarium: Because stalks between stage 5 and 6 egg chambers have the same number of cells as those between stage 1 and 3 chambers, it is thought that stalk cells do not divide after germarium. To experimentally refine the window of time in which stalk cells stop dividing, both DAPI and PI chromosome stains were used to visualize mitosis. Metaphase and anaphase chromosomes are highly condensed and appear significantly brighter than interphase chromosomes in the presence of these dyes. As expected, such condensed chromosomes were clearly visible in ~1.2%

(67/5700) of the division-competent follicle cells surrounding stage 1 and 2 egg chambers (data not shown). In contrast, we scored 1050 DAPI-stained mature stalk cells between stage 1 and 3 egg chambers without observing any evidence of mitosis. We therefore conclude that, unlike most of the follicle cells, stalk cells cease dividing in the germarium.

To identify the latest stage in the germarium in which divisions of stalk and polar cell precursors are detected, we marked these precursors with Big Brain (Bib) antibody (Larkin *et al.* 1996; Doherty *et al.* 1997). Bib antibody specifically marks stalk and polar cell precursors in the germarium in a characteristic subcellular distribution pattern (Larkin *et al.* 1996; see Figure 5I). We found condensed PI staining indicative of mitosis in Bib-positive cells in the early stages of egg chamber pinching (Figure 3), but not in later stages of pinching. We therefore conclude that the precursors for the stalk cells and polar cells are still competent to divide in the beginning of the egg chamber pinch.

Restricted clones in stalk cells and polar cells coincide: The fact that stalk and polar cells both finish dividing early allowed us to identify these two subgroups as

TABLE 2
Chi-square test for correlation of SC and PC clones

	Total counted		Average size (cells)				
Total PC-SC-PC units	1084						
SC clones alone (sc, -pc)	56		2				
PC clones alone (-sc, pc)	30		2				
SC-PC clones together	24		4				
	Observed		Expected ^a				
	sc	-sc	sc	-sc			
pc	24	30	54	pc	4	50	54
-pc	56	974	1030	-pc	76	954	1030
	80	1004	1084		80	1004	1084

$\chi^2 = \sum (O - E)^2/E = 113$, P value = <0.001

sc, stalk cell clones; pc, polar cell clones.

^a Expected values were calculated with the assumption that clones of each type were independently induced.

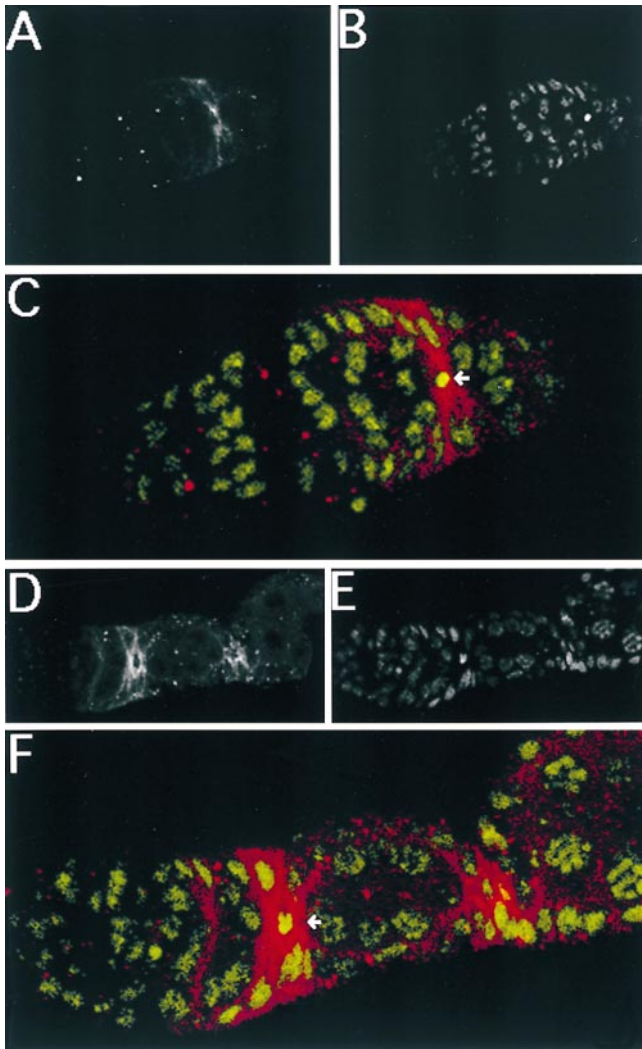

Figure 3.—Bib-positive precursors still divide in the border of regions 2b and 3 in germarium. Wild-type ovaries are double stained with Bib antibody (A and D; red in C and F) and PI (B and E; green in C and F). Condensed chromatin (B and E), indicative of mitotic cells, is detected in precursor cells that align between the egg chambers before intercalation (C and F, arrows).

small clones in our clonal analysis, and to look for a common lineage relationship between them. If such a lineage relationship exists, and if cells belonging to the common progenitor cells are dividing during stage 2b, then such cells should sometimes be marked in our mosaic experiments. A precursor thus marked should occasionally divide to produce both a marked stalk cell and a marked polar cell, leading to coincident restricted clones representing both cell types in PC-SC-PC units on either the anterior or posterior end of stage 6 egg chambers (Figure 1; see materials and methods). A low number of coincident clones would also be expected as a result of independent mitotic events. We observed coincident clones (Figure 4) at a significantly high frequency (Figure 2A): the probability of the observed coincident stalk cell and polar cell clones arising by independent mitotic events is calculated to be <0.001 (Table 2; see materials and meth-

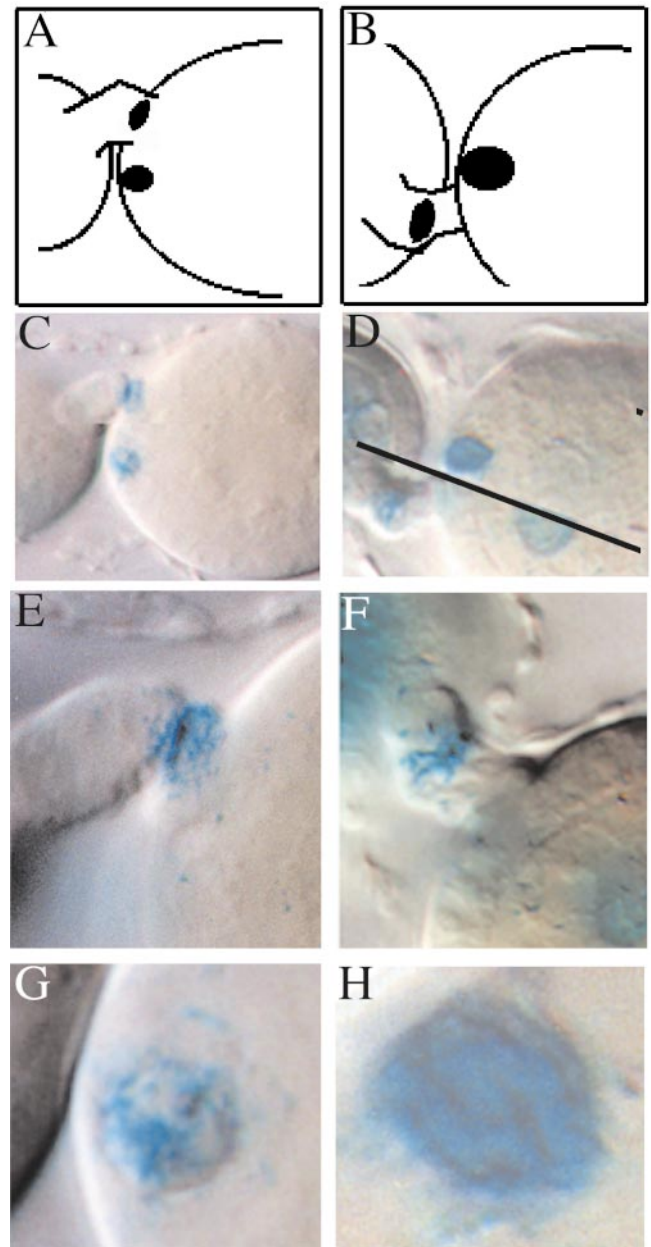

Figure 4.—Restricted clones in stalk cells and polar cells coincide. Small clones (schematic representation, A and B) that span stalk cells and polar cells can be continuous (A, C, E, and G, 70%) or discontinuous (B, D, F, and H, 30%). By stage 6 in oogenesis, the point of attachment of the stalk to the polar cells is released and the egg chamber can rotate (see Figure 1, S8). (E and F) Higher magnification of stalk cells. (G and H) Higher magnification of polar cells.

ods). In contrast, the frequency of stalk cell clone and main body clone coincidence is far more consistent with independent induction ($P \sim 1$; Table 3). We conclude, therefore, that stalk cells and polar cells have a common precursor that is distinct from the precursors of main body follicle cells (see Figure 8).

The restricted clones in stalk cells and polar cells that coincide in a unit (Figure 1) were either continuous (70%) or discontinuous (30%). Discontinuous clones

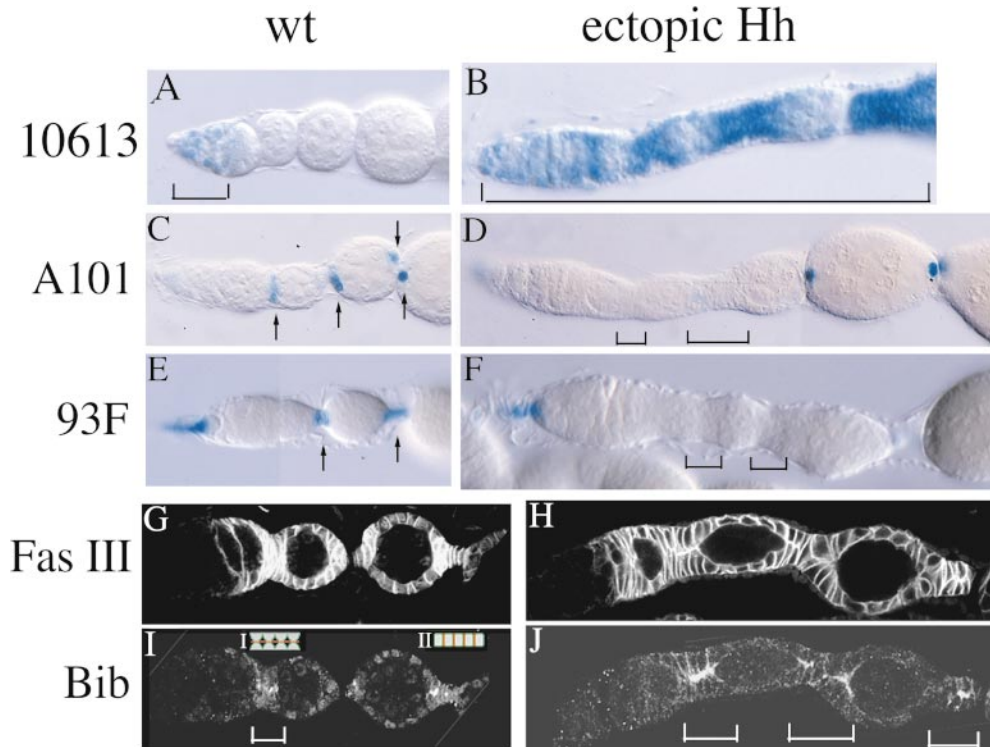

Figure 5.—Ectopic expression of Hedgehog in the gerarium prolongs the Bib-positive precursor stage. Ovaries from wild-type (A, C, E, G, and I) and *HSPfp; aTub84BFTy+FRThh* (48 hr after *hh* induction B, D, F, H, and J) animals stained with *patched* enhancer trap line (A and B), polar cell marker *A101* (C and D), stalk cell marker *93F* (E and F), and antibodies for FasIII (G and H) and Bib (I and J). The *patched* enhancer trap line (10613), which in wild-type ovarioles is expressed in the inner sheath cells (A, bracket), marks the cells that are affected by ectopic expression of Hh (B, bracket). Because of persistent ectopic expression of Hh, long, stalk-like structures are formed. The cells in these stalk-like structures do not differentiate to form the *A101*-positive polar cells (D, bracket) or *93F* positive stalk cells (F, bracket). Instead, the Bib- and FasIII-

positive, morphologically distinct precursor stage is prolonged in the cells expressing ectopic Hh (H and J). In wild-type ovaries, Bib stains the apical tips of precursors for stalk and polar cells when they are aligned to intercalate in the gerarium (horizontal pattern, I-I) and in the membranes between the cells in mature stalks (vertical pattern, I-II). Under sustained ectopic expression of Hh, apical precursor staining of Bib antibody staining is detected in follicle cells located between stage 1 to 4 egg chambers (J, brackets).

in a precursor stage: at later time points, some of the cells in the long stalks “leak through” the Hh-induced precursor block and differentiate to form extra stalk or polar cells, further evidence that these cells are precursors for polar and stalk cells (Figure 6E, arrow).

Hedgehog can induce ectopic stalk cells and polar cells that coincide with a defective oocyte anterior-posterior axis: Three days after persistent Hh induction, patchy *patched* expression, indicative of Hh action, extended to later-stage egg chambers (Figure 6, B–D). Interestingly, in addition to previously observed ectopic polar cells (Forbes *et al.* 1996a,b; Figure 6F), we also observed ectopic stalk cells (Figure 6, F–I) in these egg chambers, suggesting that ectopic Hh can induce both fates. Therefore, ectopic Hh affects not only the stalk cell and polar cell fates in their normal location, but it can also induce these fates in ectopic locations, probably by transiently inducing the stalk and polar cell precursor stage. We have shown by clonal analysis that stalk and polar cells have a common precursor that is separate from a precursor for egg chamber follicle cells. These data show that ectopic Hh has a capacity to induce this precursor fate.

Coinciding with the ectopic polar cells, an anterior-posterior axis defect was detected in the underlying oocyte. The typical migration of the oocyte nucleus from

the posterior to a dorsal-anterior location failed to occur (Figure 6F). In addition, Kin:βgal fusion protein failed to localize posteriorly, and the oocyte microtubule network was defective (Figure 6K; data not shown). These phenotypes have been previously observed in mutants that compromise the epidermal growth factor receptor or Notch pathways in posterior follicle cells, thereby altering the follicle cell-oocyte signaling that is required for proper anterior-posterior axis formation (reviewed in Anderson 1995).

Stall affects stalk cell migration but not the primary cell fate: Mutants in *stall* display defects in egg chamber separation from the gerarium that are morphologically comparable to the *Notch* loss-of-function defect (Schübach and Wieschaus 1991; Figure 7A). We asked whether this defect was caused by the elimination of stalk cell fate, as in *N^{ts}* mutants (Ruohola *et al.* 1991). The expression of the enhancer trap line *93F* (Ruohola *et al.* 1991; Zaffran *et al.* 1997), which marks stalk cells, was examined in *stall* mutants. Although no stalk structures were detected, groups of *93F*-positive cells were observed in the mutant germaria, suggesting that cells continue to acquire stalk cell fate (Figure 7C). The ratio of *93F*-positive cells to germline cysts found in *stall* germaria is consistent with the number of cells found in wild-type stalks (data not shown). Because *93F* marks

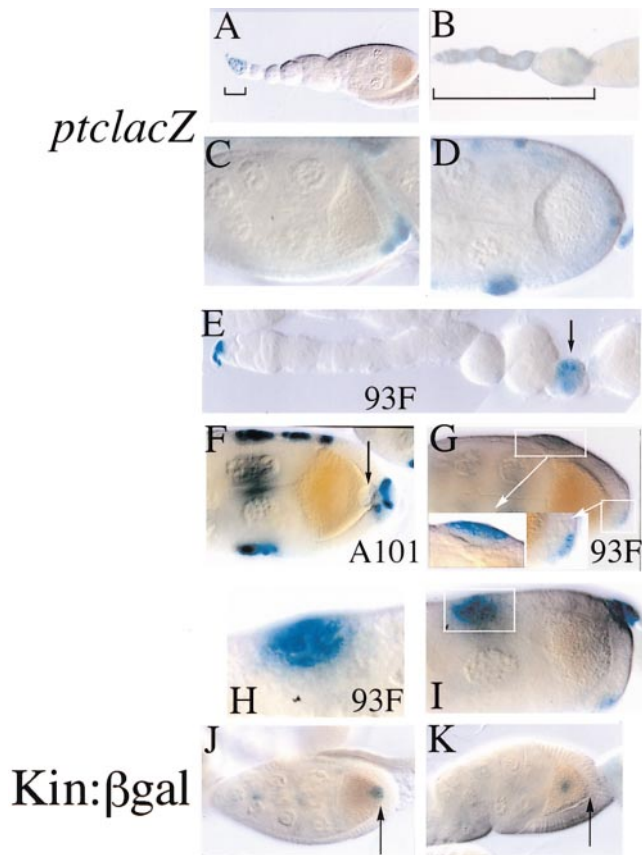

Figure 6.—Hedgehog can induce ectopic stalk cells and polar cells that coincide with a defective oocyte anterior-posterior axis. Wild-type *ptclacZ* expression (A) is expanded to stage 1 to 8 egg chambers 3 days after Hh induction (B–D). In this time point, some of the cells located in long, stalk-like structures begin to express the stalk cell marker 93F (E, arrow, ~20 cells). Receipt of the ectopic Hh signal indicated by ectopic patchy expression of *ptclacZ* (B–D) induces ectopic polar (A101, F) and stalk cell (93F, G–I) fates in the follicle cell layer surrounding the germline. The anterior-posterior axis defect is detected in the underlying oocyte, as indicated by mislocalization of the Kin:βgal fusion protein (K, 46% = 25/54 stage 8 to 9 egg chambers) and nucleus (E, arrow). Controls show normal posterior localization of Kin:βgal (J). H is an enlargement of ectopic stalk cells (boxed area in I). F and G are 1/2, J and K are 1/4, A and B are 1/8, and H is 3× magnification of C–E and I.

the terminal filament cells as well as the stalk cells in wild-type ovaries, it was formally possible that the 93F positive cells in *stall* germaria represented terminal filament cells. To rule out this possibility, we examined *stall* mutant ovaries with an independent terminal filament marker, *Gal4(127)* (Figure 7D). β-Galactosidase protein visualization of *stall* mutant germaria carrying *UAS-LacZ* under control of *Gal4(127)* displayed only the wild-type terminal filament expression pattern (Figure 7E, arrowhead). In addition, some cells that expressed an exclusive stalk cell marker, *l(3)1344*, were detected in *stall* mutant germaria (Forbes *et al.* 1996a; data not shown). We conclude that the 93F-positive cells in *stall*

mutant germaria are stalk cells. Furthermore, no obvious defect in the polar cell population was detected in *stall* mutant germaria upon examining the expression of the *A101* enhancer trap line (Figure 5B). These data suggest that the early lineage decision between polar cell and stalk cell fate occurs normally in the *stall* mutant. We conclude that stalk cells are defective in a subsequent differentiation or migration step.

DISCUSSION

We used clonal analysis to better characterize stalk and polar cell differentiation. We determined that stalk cells stop dividing during the early egg chamber pinch, when the associated cyst is in region 3 of the germarium. Furthermore, based on the tight correlation of restricted clones in stalk and polar cells, we propose a model in which these two groups share a common lineage (Figure 8). Supporting evidence for this hypothesis was obtained by analyzing the cell fate changes generated by ectopic expression of Hh. We have shown that Hedgehog can induce both stalk cell and polar cell fates in ectopic positions, probably by inducing ectopic precursor fate. Ectopic polar cells coincide with a defective oocyte anterior-posterior axis, indicative of abnormal follicle cell-oocyte signaling.

Role of Notch in stalk and polar cell lineage: The transmembrane receptor Notch functions in a wide variety of cell fate specification events in multiple species (reviewed see Artavanis-Tsakonas *et al.* 1995). In oogenesis, Notch and its ligand Delta are involved in the fate determination of stalk and polar cells (Ruohola *et al.* 1991; Xu *et al.* 1992; Bender *et al.* 1993; Larkin *et al.* 1996). Loss-of-function alleles or *Notch* and *Delta* cause a pinching-off defect in which cysts accumulate in the germarium. Analysis of enhancer trap markers for stalk and polar cell fate reveal that stalk cell formation is blocked in *N^{ts}* mutants, while polar cells accumulate in affected germaria (Ruohola *et al.* 1991). Expression of a constitutively active Notch construct (*caN*) induces extremely long, stalk-like structures, which, in the most extreme phenotype, contain neither stalk nor polar cells (Larkin *et al.* 1996). Instead, they display markers and morphology indicative of precursors in region 3 of the germarium. Overexpression of Delta in oogenesis produces similar phenotypes (Larkin *et al.* 1999). We have now shown that stalk and polar cells share a common lineage. Therefore, we propose that follicle cell stem cells produce precursors that are clonally distinct from other precursor cells, and divide to produce cells that assume either stalk or polar cell fate (Figure 8). The lineage relationship between stalk and polar cells clarifies previous genetic models.

Cessation of stalk and polar cell division: Polar cells and stalk cells both stop dividing very early in oogenesis. This has been confirmed by cell morphology, clonal analysis, and visualization of mitosis (Margolis and

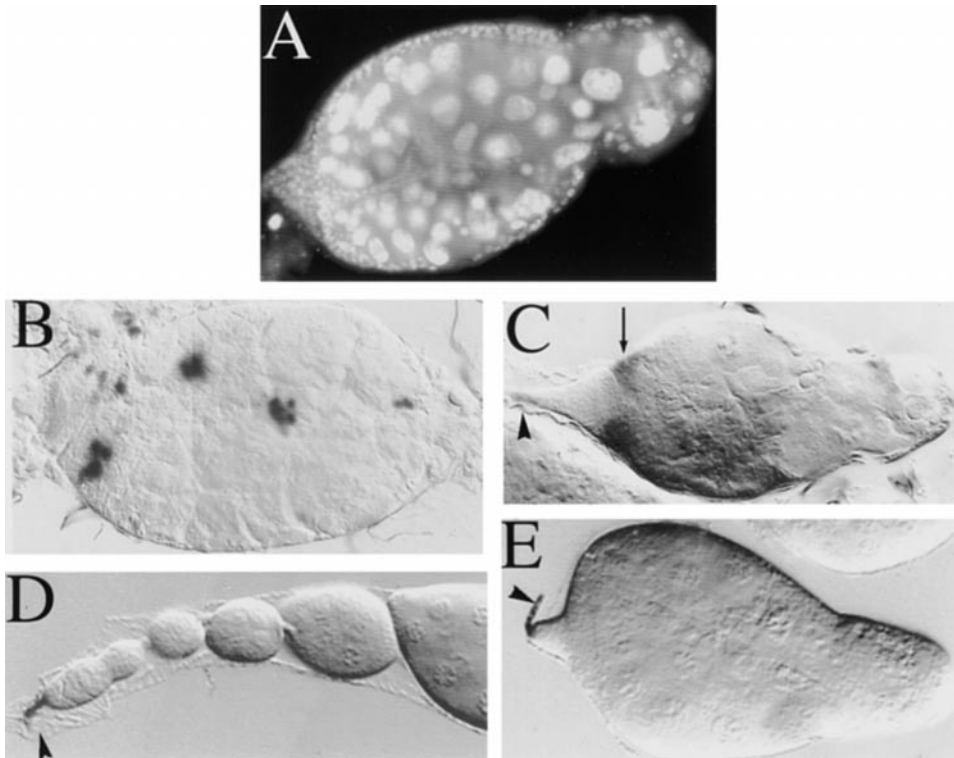

Figure 7.—*stall* affects stalk cell migration but not the primary cell fate. DAPI staining of *stall* mutant (*PH57/PA49*) shows the accumulation of germline cysts in the enlarged germarium (A). The *stall* mutant (*PH57/AWK26*), which lacks morphological stalks, still allows polar cells and stalk cells to differentiate on the basis of *A101* (B) and *93F* (C, arrow) expression. All allele combinations of *stall* we analyzed expressed *93F* and *A101* in the enlarged germaria. *93F* is also expressed in terminal filament (tf) cells (C, arrow-head). *GALA(127)* is only expressed in the tf cells in wild-type and *stall* mutant ovarioles (D and E, arrow-head), indicating that no expansion of terminal filament cell fate is detected in the *stall* mutant. In all cases, anterior is on the left.

Spradling 1995; see results). Mitotic figures are not seen in mature stalk cells with DAPI staining. In addition, using PI chromosome stain in conjunction with antibody against Bib protein, we see mitotic figures in Bib-positive cells in region 3 of the germarium. Therefore, the cells are still competent to divide just before intercalation. Our data offer an alternative interpretation of data reported by Margolis and Spradling (1995). Based on the small size of polar cell clonal patches in stage 10 chambers, they concluded that polar cells cease division in stage 2b of the germarium, before the beginning of egg chamber pinching. Our analysis of earlier

stages suggests that the patches Margolis and Spradling observed may have represented parts of bigger clones that included stalk cells, which are often difficult to detect around stage 10 egg chambers. In our model, both stalk and polar cells cease division in region 3 of the germarium.

Hedgehog can induce stalk cell and polar cell fates by affecting the precursor stage, while *stall* acts late in stalk formation: The results of experiments performed with ectopic *hh* expression show a proliferation of follicle cells that fail to express stalk cell markers (Forbes *et al.* 1996a). Our data suggest that overexpression of Hh in germarium keeps the stalk cells and polar cells in a precursor stage. Interestingly, Hh appears to induce precursor fate, even in ectopic locations, because patchy expression of Hh among the follicle cells surrounding late-stage egg chambers correlates with both ectopic stalk cell and polar cell fates. While Hh functions early in the differentiation of these cells, we find that the *stall* mutant (Schüpbach and Wieschaus 1991), which also affects stalk formation, functions downstream of the initial cell fate decision (Figure 8).

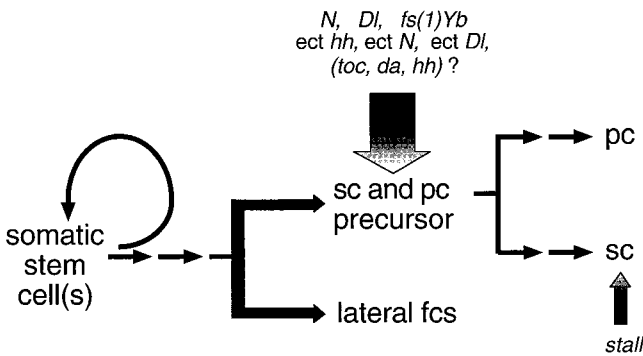

Figure 8.—Model for stalk cell and polar cell differentiation. Our data suggest that stalk cells and polar cells are related by lineage. Ectopic Hh and defects in *fs(1)Yb* and the Notch pathway affect the lineage by altering the precursor stage. *daughterless* and *toucan* also act in this process. In contrast, *stall* does not affect the lineage decision, but it is required later for stalk formation.

Ectopic polar cells among the follicle cells surrounding the oocyte are correlated with a defect in the oocyte anterior-posterior axis, indicative of defective follicle cell-oocyte signaling. Similar phenotypes have been observed in ovaries with *patched* mutant follicle cell clones (Y. Zhang and D. Kalderon, personal communication). Therefore, as expected, ectopic Hh expression mimics *patched* loss-of-function phenotypes in egg chamber follicle cells.

These experiments strongly suggest that two special-

ized subgroups of follicle cells, stalk cells and polar cells, are related by lineage. The mutant data demonstrate that cell-cell communication affects this lineage decision. Further experiments are required to determine whether intrinsic information is delivered to one of these groups by asymmetric division. It will be interesting to analyze whether components like Numb, which are required for asymmetric cell division in neuroblasts, are required in the stalk cell/polar cell lineage.

We thank Drs. A. Spradling, T. Schüpbach, and members of the Ruohola-Baker lab for helpful comments on the manuscript. We also thank the Spradling, Schüpbach, and Struhl laboratories for providing fly lines that made this study possible. Many thanks to Ingo Ruczinski, Dr. Charles Kooperberg, and Shelley Slate for their invaluable help with the statistical analysis. This work was supported by the following grants to H.R.-B.: Established Investigatorship Award from the American Heart Association (AHA 95002990), a research grant from the March of Dimes Birth Defect Foundation (FY97-0425), National Institutes of Health (R01 HD 32464), and a Pew Memorial Trust, Pew Scholarship in the Biomedical Sciences. M.K.L. was supported by a Fellowship Cytotherapeutics Corporation.

LITERATURE CITED

- Anderson, K., 1995 One signal, two body axes. *Science* **269**: 489–490.
- Artavanis-Tsakonas, S., K. Matsuno and M. E. Fortini, 1995 Notch signaling. *Science* **268**: 225–232.
- Basler, K., and G. Struhl, 1994 Compartment boundaries and the control of *Drosophila* limb pattern by hedgehog protein. *Nature* **368**: 188.
- Becker, H. J., 1957 Über Röntgenmosaicflecken und Defecmutationen am Auge von *Drosophila* und die Entwicklungsphysiologie des Auges. *Z. Induk. Abst. Vererb. Lehre* **88**: 333–373.
- Bender, L. B., P. J. Kooh and M. A. Muskavitch, 1993 Complex function and expression of *Delta* during *Drosophila* oogenesis. *Genetics* **133**: 967–978.
- Bobola, N., R. P. Jansen, T. H. Shin and K. Nasmyth, 1996 Asymmetric accumulation of Ash1p in postanaphase nuclei depends on a myosin and restricts yeast mating-type switching to mother cells. *Cell* **84**: 699–709.
- Brower, D. L., R. J. Smith and M. Wilcox, 1981 Differentiation within the gonads of *Drosophila* revealed by immunofluorescence. *J. Embryol. Exp. Morphol.* **63**: 233–242.
- Clark I., E. Giniger, H. Ruohola-Baker, L. Y. Jan and Y. N. Jan, 1994 Transient posterior localization of a kinesin fusion protein reflects anteroposterior polarity of the *Drosophila* oocyte. *Curr. Biol.* **4**: 289–300.
- Cummings, C., and C. Cronmiller, 1994 The *daughterless* gene functions together with *Notch* and *Delta* in the control of ovarian follicle development in *Drosophila*. *Development* **120**: 381–394.
- Doherty, D., L. Y. Jan and Y. N. Jan, 1997 The *Drosophila* neurogenic gene *big brain*, which encodes a membrane-associated protein, acts cell autonomously and can act synergistically with *Notch* and *Delta*. *Development* **124**: 3881–3893.
- Forbes, A. J., H. Lin, P. W. Ingham and A. C. Spradling, 1996a *hedgehog* is required for the proliferation and specification of ovarian somatic cells prior to egg chamber formation in *Drosophila*. *Development* **122**: 1125–1135.
- Forbes, A. J., A. C. Spradling, P. W. Ingham and H. Lin, 1996b The role of segment polarity genes during early oogenesis in *Drosophila*. *Development* **122**: 3283–3294.
- Gho, M., and F. Schweisguth, 1998 Frizzled signalling controls orientation of asymmetric sense organ precursor cell division in *Drosophila*. *Nature* **393**: 178–181.
- Golic, K., 1991 Site-specific recombination between homologous chromosomes in *Drosophila*. *Science* **252**: 958–961.
- Grammont, M., B. Dastugue and J. Couderc, 1997 The *Drosophila toucan (toc)* gene is required in germline cells for the somatic cell patterning during oogenesis. *Development* **124**: 4917–4926.
- Harrison, D., and N. Perrimon, 1993 A simple and efficient generation of marked clones in *Drosophila*. *Curr. Biol.* **3**: 424–433.
- Ingham, P. W., 1995 Signalling by hedgehog family proteins in *Drosophila* and vertebrate development. *Curr. Opin. Genet. Dev.* **5**: 528–534.
- Jan, Y. N., and L. Y. Jan, 1998 Asymmetric cell division. *Nature* **392**: 775–778.
- Johnson, R., and C. Tabin, 1995 The long and short of Hedgehog signaling. *Cell* **81**: 313–316.
- Johnson, E., S. Wayne and R. Nagoshi, 1995 *fs(1)Yb* is required for ovary follicle cell differentiation in *Drosophila melanogaster* and has genetic interactions with the Notch group of neurogenic genes. *Genetics* **140**: 207–217.
- King, R. C., 1970 *Ovarian Development in Drosophila melanogaster*. Academic Press, New York.
- Larkin, M. K., K. Holder, C. Yost, E. Giniger and H. Ruohola-Baker, 1996 Expression of constitutively active Notch arrests follicle cells at a precursor stage during *Drosophila* oogenesis and disrupts the anterior-posterior axis of the oocyte. *Development* **122**: 3639–3650.
- Larkin, M. K., W.-M. Deng, K. Holder, M. Tworoger and H. Ruohola-Baker, 1999 Role of Notch pathway in terminal follicle cell differentiation during *Drosophila* oogenesis. *Dev. Genes Evol.* (in press).
- Margolis, J., and A. Spradling, 1995 Identification and behavior of epithelial stem cells in the *Drosophila* ovary. *Development* **121**: 3797–3807.
- Perrimon, N., 1995 Hedgehog and beyond. *Cell* **80**: 517–520.
- Ray, R., and T. Schüpbach, 1996 Intercellular signaling and the polarization body axes during *Drosophila* oogenesis. *Genes Dev.* **10**: 1711–1723.
- Rongo, C., and R. Lehmann, 1996 Regulated synthesis, transport and assembly of the *Drosophila* germ plasm. *Trends Genet.* **12**: 102–109.
- Ruohola, H., K. A. Bremer, D. Baker, J. R. Swedlow, L. Jan *et al.*, 1991 Role of neurogenic genes in establishment of follicle cell fate and oocyte polarity during oogenesis in *Drosophila*. *Cell* **66**: 433–449.
- Ruohola-Baker, H., L. Y. Jan and Y. N. Jan, 1994 The role of gene cassettes in axis formation during *Drosophila* oogenesis. *Trends Genet.* **10**: 89–94.
- Schüpbach, T., and E. Wieschaus, 1991 Female sterile mutations on the second chromosome of *Drosophila melanogaster*. II. Mutations blocking oogenesis or altering egg morphology. *Genetics* **129**: 1119–1136.
- Sil, A., and I. Herskowitz, 1996 Identification of an asymmetrically localized determinant, Ash1p, required for lineage specific transcription of the yeast HO gene. *Cell* **84**: 711–722.
- Spradling, A., 1993 Developmental genetics of oogenesis, pp. 1–70 in *The Development of D. melanogaster*, edited by M. Bate and A. Martínez Arias. Cold Spring Harbor Laboratory Press, Cold Spring Harbor, NY.
- Taylor, J. R., 1997 *An Introduction to Error Analysis*. University Science Books, Sausalito, CA.
- Wolff, T., and D. F. Ready, 1993 Pattern formation in the *Drosophila* retina, pp. 1277–1326 in *The Development of D. melanogaster*, edited by M. Bate and A. Martínez Arias. Cold Spring Harbor Laboratory Press, Cold Spring Harbor, NY.
- Xu, T., L. Caron, R. Fehon and S. Artavanis-Tsakonas, 1992 The involvement of the Notch locus in *Drosophila* oogenesis. *Development* **115**: 913–922.
- Zaffran, S., M. Astier, D. Gratecos and M. Sémériva, 1997 The *held out wings (how)* *Drosophila* gene encodes a putative RNA-binding protein involved in the control of muscular and cardiac activity. *Development* **124**: 2087–2098.

Communicating editor: T. Schüpbach