

NATIONAL AERONAUTICS AND SPACE ADMINISTRATION

Gravity Probe B Experiment

“Testing Einstein’s Universe”

Press Kit

April 2004

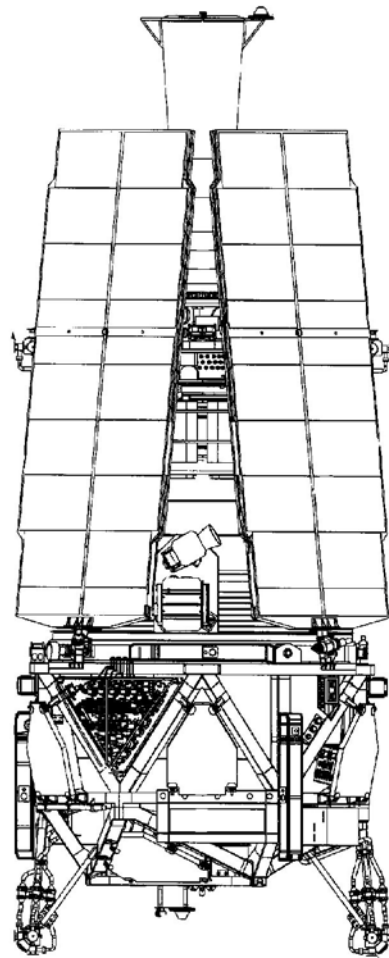

Media Contacts

Donald Savage Headquarters Washington, D.C.	Policy/Program Management	202/358-1547 donald.savage@hq.nasa.gov
Steve Roy Marshall Space Flight Center Huntsville, AL	Program Management/Science	256/544-6535 steve.roy @msfc.nasa.gov
Bob Kahn Stanford University Stanford, CA	Science/Technology & Mission Operations	650/723-2540 kahn@relgyro.stanford.edu
Tom Langenstein Stanford University Stanford, CA	Science/Technology & Mission Operations	650/725-4108 tom@relgyro.stanford.edu
Buddy Nelson Lockheed Martin Palo Alto, CA	Space Vehicle & Payload	510/797-0349 buddynelson@mac.com
George Diller Kennedy Space Center Cape Canaveral, FL	Launch Operations	321/867-2468 george.h.diller@nasa.gov

Contents

GENERAL RELEASE & MEDIA SERVICES INFORMATION	5
GRAVITY PROBE B IN A NUTSHELL.....	9
GENERAL RELATIVITY — A BRIEF INTRODUCTION.....	17
THE GP-B EXPERIMENT.....	27
THE SPACE VEHICLE	31
THE MISSION.....	39
THE AMAZING TECHNOLOGY OF GP-B	49
SEVEN NEAR ZEROES	59
UNIQUE INVENTIONS & INNOVATIONS.....	61
SPINOFFS FROM GP-B.....	65

General Release & Media Services Information

GENERAL RELEASE

WORLD'S MOST PRECISE GYROSCOPES READY TO TEST EINSTEIN

The NASA spacecraft designed to test two important predictions of Albert Einstein's general theory of relativity is set to launch site from Vandenberg Air Force Base, Calif., April 17.

NASA's Gravity Probe B mission, also known as GP-B, will use four ultra-precise gyroscopes, orbiting the Earth in a unique satellite, to experimentally test two extraordinary predictions of Einstein's 1916 theory that space and time are distorted by the presence of massive objects. The two effects being tested are: 1) The geodetic effect—the amount by which the Earth warps local spacetime in which it resides, and 2) The frame-dragging effect—the amount by which the Earth drags local spacetime around with it as it rotates.

“Gravity Probe-B has the potential to uncover fundamental properties of the invisible Universe—a Universe which seems very bizarre and alien to our everyday perceptions yet one that Einstein tried to show us almost a century ago,” said Dr. Anne Kinney, director of the astronomy and physics div. in NASA's Office of Space Science, Washington. “Testing the key aspects of Einstein's theory, such as GP-B will do, will provide crucial information to science just as it has already helped America by pushing technological progress in developing the tools needed for these ultra-precise measurements.”

Once placed in its polar orbit of 640 kilometers (400 miles) above Earth, the Gravity Probe B spacecraft will circle the globe every 97.5 minutes, crossing over both poles. In-orbit checkout and calibration is scheduled to last 40-60 days, followed by a 13-month science-data acquisition period and a two-month post-science period for calibrations.

To test the general theory of relativity, Gravity Probe B will monitor any drift in the gyroscopes' spin axis alignment in relation to its guide star, IM Pegasi (HR 8703). Over the course of a year, the anticipated spin axis drift for the geodetic effect is a minuscule angle of 6,614.4 milliarcseconds, and the anticipated spin axis drift for the frame-dragging effect is even smaller—only 40.9 milliarcseconds. To get a sense of how small these angles are, if you climbed a slope of 40.9 milliarcseconds for 100 miles, you would rise only one inch in altitude.

During the mission, data from the GP-B Space Vehicle will be received a minimum of two times each day. Either Earth-based ground stations or NASA's data relay satellites can receive the information. Controllers will be able to communicate with the orbiting Space Vehicle from the Mission Operations Center at Stanford University.

Data will include Space Vehicle and instrument performance, as well as the very precise measurements of the gyroscopes' spin-axis orientation. By 2005 the Gravity Probe B mission will be complete, and a one-year period is planned for scientific analysis of the data.

"Developing GP-B has been a supreme challenge requiring the skillful integration of an extraordinary range of new technologies," said Professor Francis Everitt of Stanford University, and the GP-B principal investigator. "It is hard to see how it could have been done without the kind of unique long-term collaboration that we have had between Stanford, Lockheed Martin, and NASA. It is wonderful to be ready for launch."

The launch from Vandenberg Air Force Base, Calif. will be broadcast live on NASA Television on the AMC-9 satellite, transponder 9C, located at 85 degrees West longitude, vertical polarization, frequency 3880.megahertz, audio 6.8 megahertz. In addition information about launch events and video will be carried on a NASA website called the Virtual Launch Control Center at:

<http://www.ksc.nasa.gov/elvnew/gpb/vlcc.htm>

NASA's Marshall Space Flight Center in Huntsville, Ala., manages the GP-B program. NASA's prime contractor for the mission, Stanford University, conceived the experiment and is responsible for the design and integration of the science instrument, as well as for mission operations and data analysis. Lockheed Martin, a major subcontractor, designed, integrated and tested the spacecraft and some of its major payload components. NASA's Kennedy Space Center in Florida and Boeing Expendable Launch Systems of Huntington Beach, Calif., are responsible for the countdown and launch of the Delta II.

More information about the Gravity Probe B mission is available at:

<http://einstein.stanford.edu/>

and

<http://www.gravityprobeb.com>

Media Services Information

NASA Television Transmission

NASA Television is broadcast on AMC-9, transponder 9, C-Band, located at 85 degrees West longitude. The frequency is 3880.0 MHz. Polarization is vertical and audio is monaural at 6.8 MHz. The tentative schedule for television transmissions of mission activities is described below; updates will be available from the Gravity Probe B Public Affairs Office at Stanford University, the Media Services Group at John F. Kennedy Space Center, Florida, and from NASA Headquarters in Washington, D.C.

NASA TV Coverage of Briefings & Launch

The launch of Gravity Probe B from Vandenberg AFB, California, is scheduled to occur at 1:09 PM EDT (10:09 AM PDT) on Saturday, April 17, 2004. Live NASA TV coverage of the launch will begin at 11:00 AM EDT (8:00 AM PDT) and will conclude shortly after spacecraft separation at approximately 2:30 PM EDT (11:30 AM PDT).

Events carried live on NASA TV will also be accessible via Webcast at <http://www.ksc.nasa.gov/nasadirect/index.htm>. Please check the NASA TV schedule for updated dates and times of mission events.

Status Reports

NASA will issue periodic status reports on mission activities. They may be accessed online at <http://einstein.stanford.edu> and <http://www.gravityprobeb.com>.

Launch Media Credentialing for Vandenberg AFB

News media desiring accreditation for the launch of Gravity Probe B should fax their request on news organization letterhead to:

30th Space Wing Public Affairs
Vandenberg Air Force Base, California
Attention: Staff Sgt. Danet

Fax: 805/606-8303

Telephone: 805/606-3595

Internet Information

Information on the mission, including an electronic copy of this press kit, press releases, fact sheets, status reports and images, is available from a variety of

sources. Stanford University operates the mission web site at **<http://einstein.stanford.edu>**.

In addition, there is a Gravity Probe B section on NASA's Marshall Space Flight Center Web site at **<http://gravityprobeb.com>**, as well as on the NASA Kennedy Space Center Web site at **<http://www.ksc.nasa.gov/elvnew/gpb/index.htm>**.

Gravity Probe B in a Nutshell

Brief Summary of the Gravity Probe B Relativity Experiment

In 1916, in what has been called one of the most brilliant creations of the human mind, Albert Einstein formulated his general theory of relativity, which stands as one of the foundational theories of modern physics. The stuff of both hard science and science fiction, Einstein's theory weaves together space, time, and gravitation, and predicts such bizarre phenomena as black holes and the expanding Universe, yet it remains arguably the least tested of scientific theories. Now, 88 years later, a team from Stanford University, NASA, and Lockheed Martin is poised to launch the Gravity Probe B spacecraft to measure two of Einstein's oddest predicted effects.

The first of these effects, known as the geodetic or curved spacetime effect, postulates that any body in space warps or curves its local spacetime. This is Einstein's theory that gravity is not an attractive *force* between bodies, as Isaac Newton believed, but rather the product of bodies moving in curved spacetime. One way to visualize this effect is to think of local spacetime as a flat bedsheet and the Earth a bowling ball lying in the middle. The heavy ball warps or puts a dent in the bedsheet, so that a marble (another celestial body) moving along the bedsheet will be inexorably drawn down the warped slope towards the massive ball. The geodetic effect being measured by Gravity Probe B is the amount of the tiny angle by which the Earth is warping its local spacetime.

The other effect, known as "frame-dragging," was postulated by Austrian physicists Josef Lense and Hans Thuring two years after Einstein published his general theory of relativity. It states that as a celestial body spins on its axis, it drags local spacetime around with it, much like a spinning rubber ball in bowl of molasses drags around some of the molasses as it spins. Particularly intriguing, the frame-dragging measurement probes a new facet of general relativity—the way in which space and time are dragged around by a rotating body. This novel effect closely parallels the way in which a rotating electrically charged body generates magnetism. For this reason it is often referred to as the "gravitomagnetic effect," and measuring it can be regarded as discovering a new force in nature, the gravitomagnetic force.

The experiment aboard the Gravity Probe-B spacecraft is designed to measure these effects with unprecedented precision and accuracy. Basically, the spacecraft consists of a polar-orbiting satellite containing four ultra-precise spherical

gyroscopes and a telescope—which is like saying that an aircraft carrier consists of a some sophisticated fighter planes and a floating runway. In other words, there’s a whole lot more going on.

The gyroscopes must be maintained in a pristine environment, in which they can spin in a vacuum, unhindered by any external forces, magnetic disturbances from Earth, or disturbances from the satellite itself. At the beginning of the experiment, the telescope (and satellite) are aligned with a distant “guide” star. The gyroscopes are aligned with the telescope, so that initially, their spin axes also point to the guide star. The gyroscopes are spun up, and over the course of a year, while keeping the telescope (and satellite) aligned with the guide star, the gyroscopes’ spin axes are monitored to detect any deflection or drift due to the geodetic and frame-dragging relativistic effects.

If the predictions based on Einstein’s theory are correct, the gyroscopes’ spin axes should slowly drift away from their initial guide star alignment—both in the satellite’s orbital plane, due to the curvature of local spacetime, and perpendicular to the orbital frame due to the frame-dragging effect. While physicists believe that the effects of relativity—especially the frame-dragging effect—are enormous in the vicinity of black holes and other massive galactic bodies, around a small planet like Earth, these effects are barely noticeable. For example, the predicted angle of spin axis deflection due to the frame-dragging effect corresponds to the width of a human hair as seen from 10 miles away!

When Stanford physicist Leonard Schiff (and independently, George Pugh at the Pentagon) first proposed this experiment in 1960, America had just created NASA, launched its first satellite, and entered the space race. Landing men on the Moon was still 10 years away. At the time, this experiment seemed rather simple, but it has taken over four decades of scientific and technological advancement to create a space-borne laboratory and measurement instrument sophisticated and precise enough to quantify these minuscule relativistic effects.

Gravity Probe-B’s measurement of the geodetic effect, the larger of the two, will be to an accuracy of 0.01%, which is far more accurate than any previous measurements, and will provide the most precise test ever of general relativity. The frame-dragging effect has never directly been measured before, but Gravity Probe-B is expected to determine its accuracy to within 1%.

At least nine new technologies had to be invented and perfected in order to carry out the Gravity Probe B experiment. The spherical gyroscopes have a stability more than a million times better than the best inertial navigation gyroscopes, and the magnetometers, called SQUIDs (Super-Conducting Quantum Interference Devices), that monitor the spin axis direction of the gyroscopes, can detect a change in spin axis alignment to an angle of approximately $1/40,000,000^{\text{th}}$ of a degree. These advances were only possible through GP-B’s unique combination of cryogenics, drag-free satellite technology and new manufacturing and measuring technologies.

Over its 40+ year lifespan, spin offs from the Gravity Probe B program have yielded many technological, commercial, and social benefits. The technological benefits include cryogenic products used in other NASA missions, Global Positioning Satellite (GPS) products used in aviation and agriculture, optical bonding and fused quartz technologies that have commercial applications, and photo diode detectors that have ramifications for digital camera improvements.

Less tangible, but perhaps most important, the Gravity Probe B program has had a profound effect on the lives and careers of numerous faculty and students—both graduate and undergraduate, and even high school students, at Stanford University and other educational institutions. Nearly 100 Ph.D. dissertations have been written on various aspects of this program, and GP-B alumni include the first woman astronaut, the CEO of a major aerospace company, professors at Harvard, Princeton, Stanford and elsewhere, and a recent Nobel Laureate in Physics.

Gravity is the most fundamental force in nature; it affects all of us all the time. But, gravity is still an enigma—we don't completely understand it. Einstein's 1916 general theory of relativity forever changed our notions of space and time, and it gave us a new way to think about gravity. If the Gravity Probe-B experiment corroborates the two predictions of general relativity, then we will have made the most precise measurement of the shape of local spacetime, and confirmed the mathematics of general relativity to a new standard of precision. If on the other hand, the results disagree with Einstein's theoretical predictions, then we may be faced with the challenge of constructing a whole new theory of the universe's structure and the motion of matter. Whatever the result, Gravity Probe B will provide us another glimpse into the sublime structure of our universe.

Quick Facts

Spacecraft

Length	6.43 meters (21 feet)
Diameter	2.64 meters (8.65 feet)
Weight	3,100 kg (3 tons)
Power	Total Power: 606 Watts (Spacecraft: 293 W, Payload: 313 W)
Batteries (2)	35 Amp Hour

Dewar

Size	2.74 meters (9 Feet) tall, 2.64 meters (8.65 feet) diameter
Contents	2,441 liters (645 gallons) superfluid helium @ 1.8 Kelvin (-271.4°C)

Telescope

Composition	Homogeneous fused quartz
Length	35.56 centimeters (14 inches)
Aperture	13.97 centimeter (5.5-inch)
Focal length	3.81 meters (12.5 feet)
Mirror diameter	14.2 centimeters (5.6 inches)

Guide Star	HR 8703 (IM Pegasi)
-------------------	---------------------

Gyroscopes (4)

Shape	Spherical (Sphericity < 40 atomic layers from perfect)
Size	3.81 centimeter (1.5-inch) diameter
Composition	Homogeneous fused quartz (Purity within 2 parts per million)
Coating	Niobium (uniform layer 1,270 nanometers thick)
Spin Rate	Between 5,000 – 10,000 RPM
Drift Rate	Less than 10^{-11} degrees/hour

Launch Vehicle

Manufacturer & Type	Boeing Delta II, Model 7920-10
Length	38.6 meters (126.2 feet)
Diameter	3 meters (10 feet)
Weight	231,821 kg (511,077 lbs or 255.5 tons)
Stages	2
Fuel	Nine (9) strap-on solid rocket motors; kerosene and liquid oxygen in first stage; hydrazine and nitrogen tetroxide in second stage

Quick Facts (Continued)

Mission

Launch Date	April 17, 2004
Site	Vandenberg Air Force Base, Lompoc, CA
Duration	12-14 months, following 40-60 days of checkout and start-up after launch

Orbit

Characteristics	Polar orbit at 640 kilometers (400 miles), passing over each pole every 48.75 minutes
Semi-major axis	7027.4 km (4,366.8 miles)
Eccentricity	0.0014
Apogee altitude	659.1 km (409.6 miles)
Perigee altitude	639.5 km (397.4 miles)
Inclination	90.007°
Argument of Perigee	71.3°
Right Ascension of ascending node	163.26°
True Anomaly	288.7

Key Measurements

Predicted Gyro Drift due to Geodetic Effect	6,614.4 milliarcseconds or 6.6 arcseconds (1.83×10^{-3} degrees)
Predicted Gyro Drift due to Frame-Dragging Effect	40.9 milliarcseconds (1.17×10^{-5} degrees)
Required Accuracy	Better than 0.5 milliarcseconds (1.39×10^{-7} degrees)

Program

Duration	43 years from original conception; 40 years of NASA funding
Cost	\$700 million dollars

Historical Time Line—Major Events

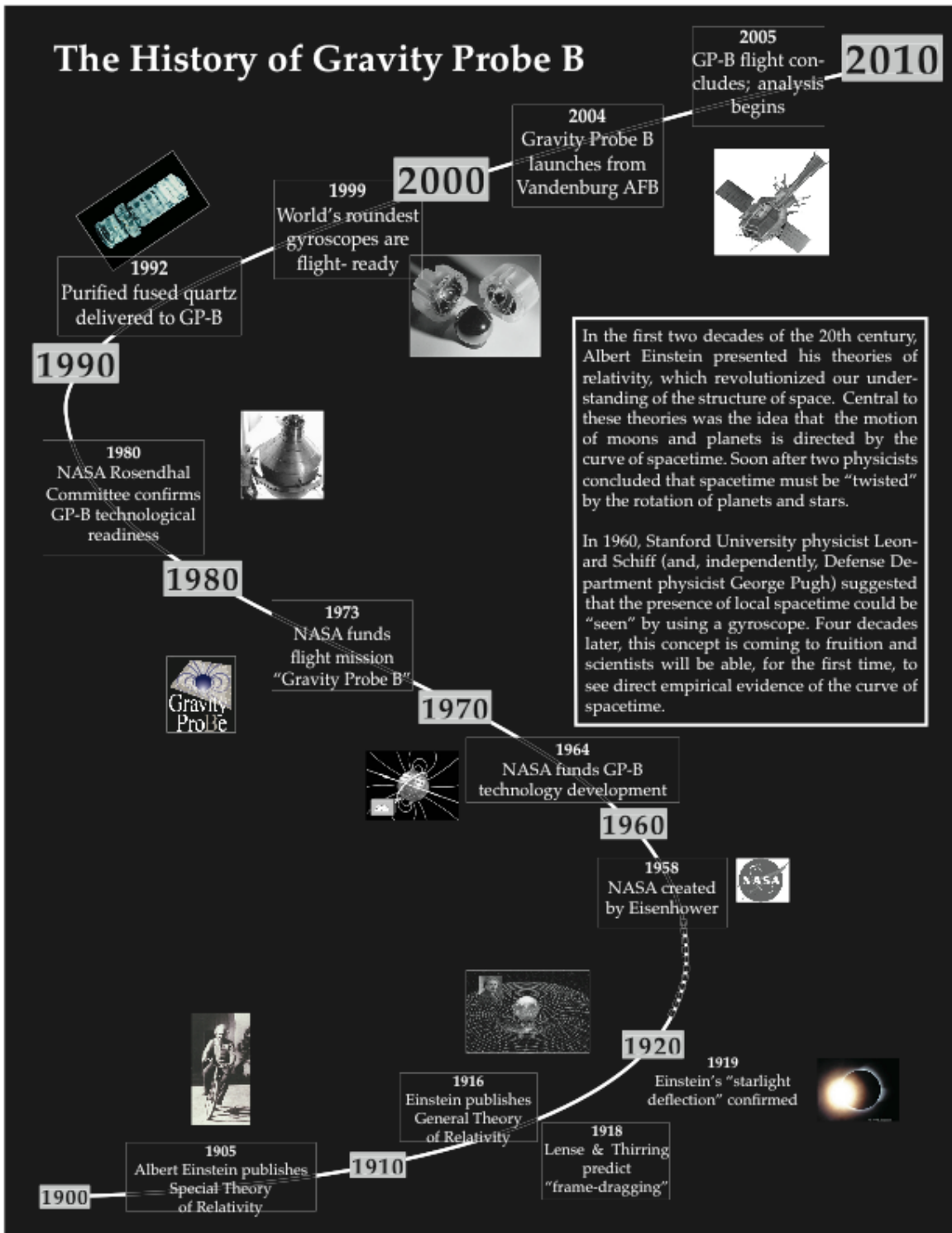

Detailed Historical Timeline

Year	Event
1905	Einstein publishes special theory of relativity
1916	Einstein publishes general theory of relativity
1918	Josef Lense & Hans Thirring predict "frame-dragging" consequence of general relativity
1919	Eddington observes "starlight deflection" predicted by general relativity
1948	Fritz London predicts a spinning superconductor would develop a magnetic moment
1952	Nordsieck invents electrically suspended gyroscope
1959	Leonard Schiff & George Pugh independently publish idea for orbiting gyroscope experiment to test general relativity
1959	Schiff publishes "An Experimental Test of the General Theory of Relativity"
1961	(to 1968) Developing basic concepts for experiment: fused telescope, gas spin-up system
1961	Schiff and Fairbank propose gyro experiment to NASA
1961	Conceptual development of SQUID idea & drag-free satellite
1963	London moment experimentally verified by three different groups, including GP-B
1964	NASA funding of GP-B commences
1968	Gyro experiment transferred from physics dept. to Hansen Experimental Physics Lab at Stanford
1968	(to 1972) Stanford collaborates with Johns Hopkins Applied Physics Lab to create drag-free TRIAD satellite
1970	Invention and demonstration of porous plug device
1972	First application of drag-free satellite in Navy's TRIAD/DISCOS navigation satellite
1973	First cryogenic test facility completed for general gyro testing, spin-up demonstrations, London moment observations, gyro dynamics studies
1973	Gyroscope experiment becomes "Gravity Probe B"
1973	J.R. Nikirk designs gyro electrical suspension system for ground-based testing
1973	(to 1983) Development of modulating gas thrusters for satellite control
1975	Low magnetic gyro test facility created with low pressure 10^{-7} Torr
1975	SQUID magnetometer system made by R. Clappier & J. Anderson
1979	J. Bates & M. Player at Univ. of Aberdeen develop measuring instrument to check homogeneity and sphericity of gyroscope
1980	W. Angele develops gyro lapping machine to polish gyro to <math>< 1</math> microinch of sphericity
1980	Gravitational Physics Committee created by NASA's Space Sciences Board, produces report, "A strategy for gravitational physics in the 1980's", put gyro experiment as #1 priority and only flight mission recommended.
1982	Dewar test flight completed thru Infra-Red Astronomy Satellite (IRAS)
1984	NASA endorses two-phase plan to build Dewar and instrument and test on 1989 Shuttle mission (STORE)

Year	Event
1984	Lockheed Martin selected as aerospace subcontractor to build payload and Dewar
1986	Plan to use Shuttle for STORE test at Vandenberg Air Force Base cancelled
1991	Stanford attempts to create Gas Management Assembly; abandoned in 2001
1992	All boules of quartz purchased from company in Germany who mined quartz in Brazil
1994	Lockheed Martin chosen to build spacecraft for gyro experiment
1995	Stanford awarded Science Mission contract to complete gyro mission
1995	All flight computers chosen to be CCCA's (486)
1996	New gyro suspension system developed, went from analog to digital & analog to enable extremely high precision
1998	(to 1999) Science Instrument assembled
2000	Flight gyroscopes completed
2000	Payload acoustic test conducted
2001	MOOG is subcontractor to build GMA
2002	MOOG delivers completed GMA
2002	Payload shipped to Lockheed
2002	Payload and spacecraft integrated
2002	Payload electronics assembly development completed
2003	Payload passes thermal vacuum test at Lockheed Martin
2003	Space vehicle shipped from Lockheed Martin to Vandenberg AFB
2004	Launch from Vandenberg AFB, California on Delta II rocket
2004	Data collection begins after 40-60 day Initialization & Orbit Checkout (IOC) period
2005	Data collection complete
2006	Data analysis complete; results published

General Relativity — A Brief Introduction

In Einstein's theory of general relativity, space is transformed from the Newtonian idea of a vast emptiness with nothing but the force of gravity to rule the motion of matter through the universe, to an invisible fabric of spacetime, which "grips" matter and directs its course.

Two Observations, One Revolution (From Gravity to Spacetime)

Newton's theory of gravity (1687) is as familiar to us as walking down a hill. As we put one foot in front of the other, the invisible force of gravity reaches out from the Earth and pulls each foot down to the ground. We feel the pull of the force and let our foot fall to the ground and we continue down the hill on our merry way. The same invisible force that keeps us Earth-bound keeps

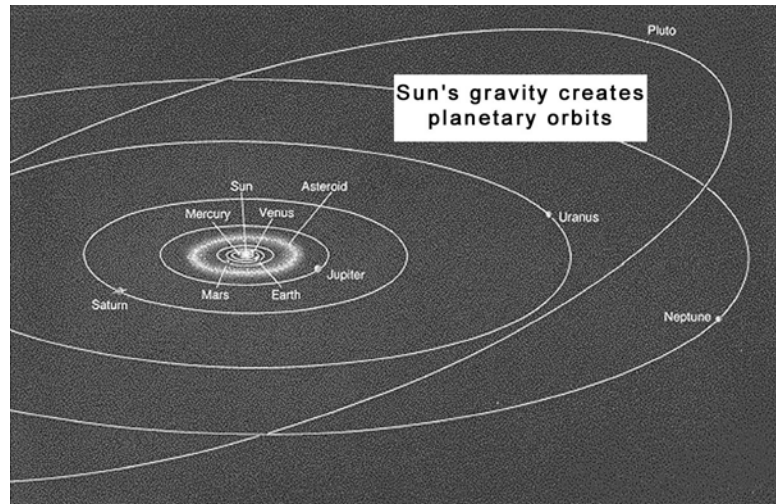

the planets in orbit around the Sun. According to Newton, the Sun's gravity reaches out across empty space and constantly pulls the planets toward it, preventing them from zooming out of our solar system.

This theory remained the strongest explanation for the planetary orbits and the apparent "falling" motion of objects on Earth for several centuries. It was not until the early 20th century when Einstein began working on his theories of relativity that Newton's theory of gravity was seriously challenged.

In 1905 and 1906 Einstein laid out his theory of special relativity in a collection of papers. Central to this theory was his claim that the speed of light in a vacuum (299,792 km/sec) was the speed limit of all matter and energy in the universe. While matter and energy could travel at speeds approaching or equaling the speed of light, they could never surpass it.

With this principle in hand, Einstein turned his attention to Newton's theory of gravity. He focused on two observations that challenged Newton's theory. The first related to the speed limit of light, and its implications for the speed limit of the force of gravity. The second related to the Equivalence Principle.

No Hypothesis

In the 'Principia' (1687), Newton states that "there is a power of gravity pertaining to all bodies proportional to the several quantities of matter which they contain." As the story goes, when Newton was questioned about how this "power of gravity" transmitted from one body to another, he responded, "I make no hypothesis."

Observation #1 - Instant Propagation Problem

Newton stated that the attractive force of gravity emanated from all matter, but he did not explain how it physically transmitted from one mass to another, nor how long this transmission took to occur. He simply inferred that the force of gravity traveled instantly across empty space, propagating from one mass to another.

However, Einstein, along with other scientists, began to question this conclusion around the turn of the 20th century. In the 19th century, Maxwell had shown that light and energy, including electricity and magnetism, propagated at the same finite rate in a vacuum— 299,792 km/sec. Einstein's theory of special relativity concluded that this rate was the speed limit for all energy in the universe. If gravity was a force that transmitted between masses in the same way light propagated through space, the force of gravity should be equally restricted to 299,792 km/sec. While crossing nearly three hundred thousand kilometers each second is extremely fast, it is not instantaneous.

Just look at the Sun's light crossing our solar system. Light, in the form of photons, flies out of the Sun at the speed of light toward the inner and outer planets. These photons cross enormous distances very rapidly. But even at this rate, minutes and even hours pass before they reach the planets (~8.3 minutes to Earth; ~5.5 hours to Pluto).

If the force of gravity could travel no faster than the speed of light, then gravity was certainly not traveling instantaneously across space. If the force of the Sun's gravity did not transmit instantly, but instead took a definite amount of time to reach the planets, then something was wrong with the actual orbits of the planets. Instead of following their observed orbits, the paths of the planets should be slightly different.

Special vs General Relativity

***Special relativity** (1905) states that time and distance are not absolutes -- the passage of one second varies according to the observer's perspective.*

***General relativity** (1916) states that gravity affects time and distance, by stretching time and contracting distance in the presence of a gravitational field.*

Was Newton's theory wrong, even though it mathematically agreed with the actual orbits of the planets? Or was Einstein's conclusion mistaken, meaning that gravity was not like other forces and actually could transmit instantly?

Einstein believed that he was not mistaken. Even though Newton's theory explained the planets' orbits to a great extent, it did not tell the whole story. Over the next ten years, Einstein worked to find the answer to the instant propagation problem.

Observation #2 - The Equivalence Principle

A second problem that Einstein encountered was related to the Equivalence Principle. This principle asserts that the motion of objects in the presence of a gravitational field **is equivalent to** the motion of objects in an accelerating frame of reference. If you drop a hammer on Earth, it falls to the ground at exactly the same rate as when you drop the hammer in an accelerating spaceship.

Let's break this down a bit. In a spaceship accelerating upwards at 9.8 m/s^2 , any object will fall to the floor at 9.8 m/s^2 . On Earth, any object you drop will accelerate to the ground at 9.8 m/s^2 . Since this is true, it raises the question of why things fall at all on Earth. If the objects are simply accelerating down, instead of "falling," could it be that the ground is actually accelerating upwards?

The mere possibility that this could be true was a problem for Einstein. If all motion appeared the same in both frames of reference (the ground and the spaceship) then gravity could not be responsible for both motions. An observer could not tell the difference between gravity and an accelerating frame of reference, so the force of gravity could not be a conclusive explanation for the falling motion of objects in the universe. What exactly was it that caused objects to accelerate towards the ground on Earth?

A New Understanding: Curved Spacetime

In 1916, Einstein addressed these two matters (the instant propagation problem and the equivalence of gravity and an accelerating frame of reference) by reconstructing the theory of gravity. Einstein presented the world with a new understanding of how the universe worked—his theory of general relativity. In this theory, space is not an empty void, but an invisible structure called spacetime. Nor is space simply a three-dimensional grid through which matter, light, and energy move. It is a structure whose shape is curved and twisted by the presence and motion of matter and energy.

Around any mass (or energy), spacetime is curved. The presence of planets, stars and galaxies deform the fabric of spacetime like a bowling ball deforms a bedsheet. (Spacetime deforms in four dimensions, so the two-dimensional bedsheet is a limited model. Try visualizing these depressions on all sides of a planet to build a more accurate image of this concept.)

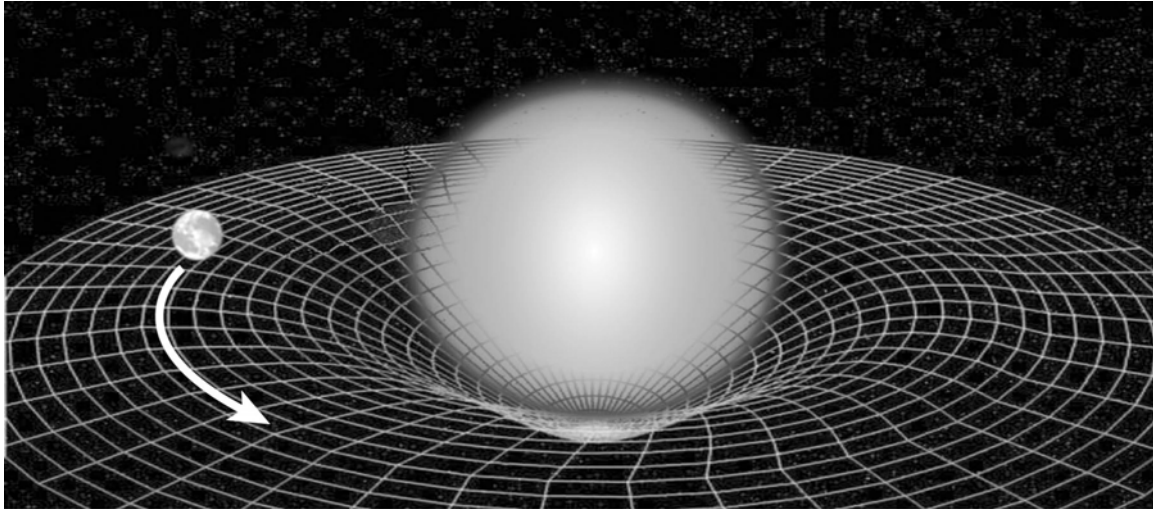

When a smaller mass passes near a larger mass, it curves toward the larger mass because spacetime itself is curved toward the larger mass. The smaller mass is not “attracted” to the larger mass by any force. The smaller mass simply follows the curve of spacetime near the larger mass. For example, the massive Sun curves spacetime around it, a curvature that reaches out to the edges of the solar system and beyond. The planets orbiting the Sun are not being pulled by the Sun; they are following the curved spacetime deformed by the Sun.

The Second Implication: Frame-Dragging

Two years after Einstein submitted his theory of curved spacetime, Austrian physicists Joseph Lense and Hans Thirring predicted that a mass could deform spacetime in a second way—through frame-dragging (1918). They proposed that the rotation of planets and stars or any rotating mass twists the structure of spacetime near that mass. Not only is local spacetime curved near the Sun, it is twisted by the Sun’s rotation. Lense and Thirring predicted this effect to be extremely small, and would become smaller farther from the rotating mass, but it would occur around every rotating mass, be it a planet, a star, a galaxy, or a person.

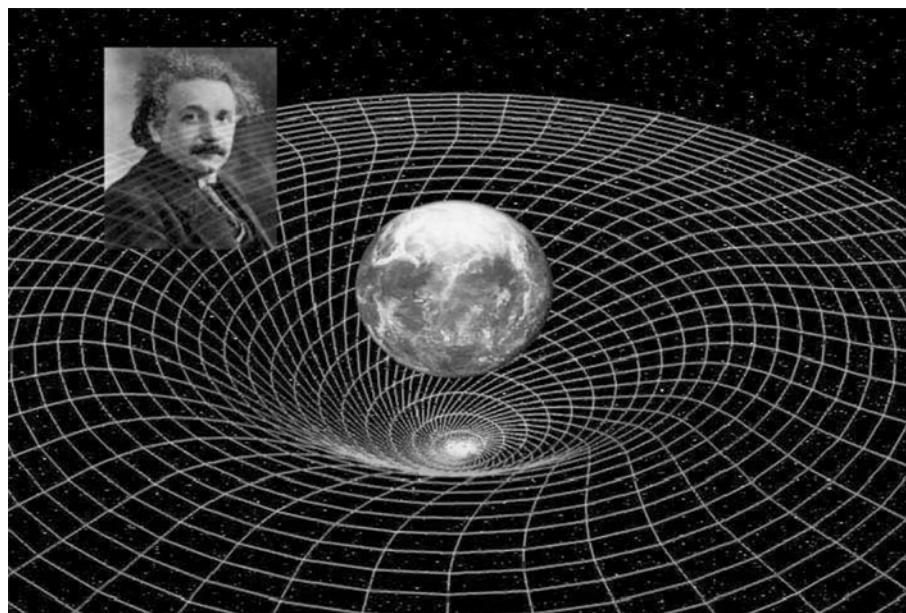

Einstein May Be Right, But Newton's Theory is Still Useful

From this description of the differences found in Newton's theory of gravity and Einstein's resolution of them, one may get the impression that Einstein's theory of general relativity completely replaces Newton's theory of gravity. Now that we are in possession of Einstein's concept of spacetime, should we toss "the force of gravity" out of our physics conversations? No. We need to retain both Einstein's theory of curved spacetime and Newton's theory of gravity in order to understand our universe.

Gravity—Force or Field?



Newton: Gravity is a force.

Bodies attract each other directly at a distance.



Einstein: Gravity is a field.

Bodies separately distort the space between them.

The combined distortions predict:

- a) all of the effects Newton calculated
- b) new effects on clocks, light-beams, massive bodies... and GP-B's gyroscopes

But Einstein knew his theory was incomplete.

Einstein's theory does provide us with a more accurate understanding of the underlying structure of the universe. However, unless one observes phenomena moving near or at the speed of light (e.g., starlight, radio waves, quasar jets) or near enormous masses (e.g., neutron stars, galaxies, black holes), the actual effects of curved spacetime and frame-dragging are barely distinguishable from those predicted by Newton's theory of gravity. In our common physical experience on Earth, where the fastest phenomena rarely reach 0.0001% of the speed of light, Newton's theory of gravity suffices. Its mathematics are much, much simpler than the mathematics of motion in curved spacetime, and it provides a functional picture of our physical world.

Previous Tests of General Relativity

Einstein was well aware that scientists would want empirical proof if they were to accept his theory of curved spacetime. He offered three specific phenomena that curved spacetime could explain—starlight deflection, the error in Newton's description of Mercury's orbital precession, and the gravitational redshift. Over the past century, scientists have closely observed these phenomena, in addition to examining a fourth phenomenon known as the Shapiro time-delay.

Starlight Deflection

The central premise of Einstein's general theory of relativity is that all matter and energy moving through the universe are affected by curved spacetime. This includes the path of light rays as they emerge from distant stars and make their way across the universe to our Earth-based telescopes and eyes. When their light passes near a massive body, such as a galaxy or our Sun, its path is deflected slightly.

In 1919, merely three years after Einstein published his theory, Frank Dyson (Great Britain's Astronomer Royal at that time), Charles Davidson, and Arthur Eddington took on the challenge of observing and measuring this phenomenon. They compared photographs of a selected area of the night sky with photographs taken of the same area during a solar eclipse. Looking at these photographs, it became apparent that stars that should have been behind the Sun were actually visible during the eclipse. Their light was bending through curved spacetime around the Sun's mass. The result was limited by the short amount of time available to make the measurement during an eclipse (about four minutes), but it confirmed Einstein's prediction to within about 20%.



In 1920, Arthur Eddington wrote a book entitled: "Space, Time, and Gravitation," which described this phenomenon. Since then, the results have been reproduced to higher and higher precision, as the technology for observing stars has improved.

Between 1969 and 1975, twelve measurements were made using radio telescopes to measure the deflection of radio waves from a distant quasar around a galaxy. These measurements matched general relativity's predictions to within 1%, and now the results are good to about 0.1%.

Mercury's Perihelion Precession

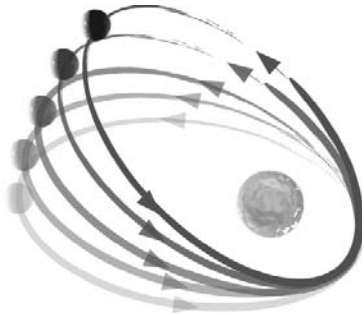

As Mercury orbits the Sun, it does not follow the exact same elliptical path each year. As it goes around, Mercury's orbit slowly turns, or precesses, in the direction of its revolution around the Sun. Its perihelion point (the point of orbit closest to the Sun) shifts slightly each time around. Astronomers have observed that over every one hundred years Mercury's orbit has precessed another 574 arcseconds around (0.16°).

Newton's theory of gravity largely accounted for this phenomenon and explained that it is caused by the gravitational perturbations of the other planets. But it did not completely account for what is observed. Each century, Mercury's orbit precesses a little farther than Newton's equations predicted—43 arcseconds more, to be precise.

When Einstein's equations were applied to the orbit of Mercury, it was a precise success. Einstein's calculations predicted that Mercury's orbit would precess 43 arcseconds/year more than Newton's equations predicted. This matched the astronomers' observations exactly. The additional 43 arcseconds were a natural effect of Mercury's motion through the spacetime curved by the Sun.

Gravitational Redshift

Another phenomenon predicted by Einstein's general theory of relativity is that light loses energy as it emerges from a gravitational field. When light loses energy, its wavelength becomes longer and the color of the light shifts toward the red end of the spectrum (thus called the "redshift").

Two key tests of the gravitational redshift are the Pound-Rebka Experiment and NASA's Gravity Probe A. In 1960, physicists Robert Pound and Glen Rebka were able to detect the redshift of high-energy gamma rays in an elevator shaft at Harvard University. They sent gamma rays up from the bottom of the shaft to a sensor 74 feet high. As the gamma rays climbed the 74 feet out of Earth's gravitational field, they lost a minuscule amount of energy (~ 2 parts in a trillion), which Pound and Rebka were able to detect. Their measurement agreed with Einstein's predictions to within 10%, later improved to about 2%.

A more precise test of the redshift was conducted by Gravity Probe A in 1976, a rocket-based experiment, also known as the Vessot-Levine test. In this experiment, a hydrogen-maser clock was launched to an altitude of 6,000 miles. The frequency

of the clock in flight was compared to the frequency of a matching clock on the ground. The experiment revealed that the frequencies of the clocks differed slightly, matching Einstein's predictions to within 70 parts per million.

Shapiro Time-Delay

In 1964, Irwin Shapiro, an astrophysicist at Harvard University, identified another phenomenon that Einstein's curved spacetime should cause: the apparent reduction of the speed of light (or electromagnetic waves) when it passes through a gravitational field.

Since 1964, a systematic program has been place to test the presence of this phenomenon to a greater and greater precision. Scientists have used radio telescopes to perform "radar ranging" on various objects whose distance is precisely known. They began by bouncing signals off Mercury and Venus.

When the line of sight between the Earth Mercury was far from the Sun, the travel time of the signal was barely delayed, if at all. But as the line of sight neared the Sun, the delay increased. Scientists predicted that, according to Einstein's equations, the signal would be delayed by 200 microseconds if it traveled right next to the Sun. When performing the experiment, the result matched this prediction.

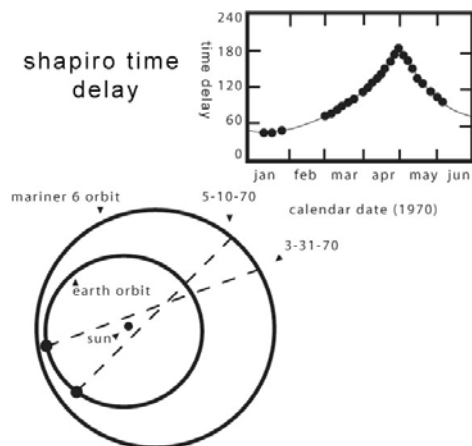

In addition to bouncing signals off of Mercury, astronomers have bounced signals off of Venus and off the Mariner 6 and Mariner 7 spacecrafts as they orbited Mars. In one of the most precise measurements of this time-delay effect, scientists used a transponder left on the surface of Mars by one of NASA's Viking landers. This experiment confirmed Einstein's prediction to within 0.1%.

Most recently, in June, 2002, Italian physicists B. Bertotti, L. Iess, and P. Tortora bounced radio waves, as they passed near the Sun, off the Cassini spacecraft—a joint NASA and Italian Space Agency satellite and probe en route to a rendezvous with Saturn in July, 2004. Their observations confirmed Einstein's prediction to within 20 parts per million.

Why Perform Another Test of General Relativity?

We wonder about the stars, about our universe, and about how things work—wonder is an important part of human life. Gravity is the most fundamental force in nature; it affects all of us all the time. But even though we've placed men on

the Moon, gravity is still an enigma—we still don't completely understand it. Einstein's 1916 general theory of relativity forever changed our notions of space and time, and it gave us a new way to think about gravity.

But, although general relativity has become a cornerstone of modern physics, it remains one of the least tested theories in physics. The frame-dragging effect has never been directly experimentally verified, and none of the previous tests of the geodetic effect come close to the precision that will be achieved by the gyroscopes and SQUID readouts of Gravity Probe B. If we are to continue to advance our knowledge of fundamental laws of nature and the universe, we must experimentally test and verify the predictions of our theories.

Gravity Probe B is one of the most sophisticated physics experiments ever attempted. Over 40 years in development, it has required the efforts of dozens of scientists and engineers at Stanford University, Lockheed Martin Space Systems Company, NASA's Marshall Space Flight Center and the Harvard-Smithsonian Center for Astrophysics, along with many others. It has spawned numerous advances in navigation technology and materials precision. Most importantly, it will provide us a glimpse into the sublime structure of our universe.

Will Gravity Probe B Verify or Refute Einstein?

Will the results of Gravity Probe B verify Einstein's theory of curved spacetime and frame-dragging, or will Einstein's theory be refuted? If the former proves true, then we will have made the most precise measurement of the shape of local spacetime and confirmed the mathematics of general relativity to a new standard of precision. If the latter proves true, then we may be faced with the challenge of constructing a new theory of the universe's structure and the motion of matter.

Will Gravity Probe B Reveal Where "Inertia" Comes From?

One of the fundamental concepts of our physical world is that all objects at rest or in motion have inertia, or a tendency to keep doing whatever they are doing. But where does this tendency or property come from? Does it come from within matter itself? Or is it related to the underlying universe?

In the late 1800's, Austrian physicist Ernst Mach proposed that the property of inertia comes from the motion of matter in the distant universe. The reason an object resists changes in motion is because it is somehow connected to the motion of all the other matter in the universe. It is a gravitational interaction that creates the property of inertia.

Gravity Probe B's investigation of frame-dragging will contribute to this question, because for distant matter to affect local matter, there has to be a gravitational link

between the two. Einstein's theory of the geometry of spacetime and the effects of frame-dragging could explain this link.

The GP-B Experiment

According to Einstein's theory of general relativity (1916), all planets and stars reside in an invisible, intangible structure of spacetime. The Earth, like all masses and energy, affects local spacetime in two ways. Earth's presence warps or curves spacetime around it, and Earth's rotation drags or twists the local spacetime frame with it (called "frame-dragging").

"Seeing" Spacetime with Gyroscopes

How could one test Einstein's theory? How could one "see" this invisible structure and measure the shape and motion of this intangible spacetime? In 1960, Stanford University physicist Leonard Schiff and his colleagues were discussing the possible scientific benefits of creating a perfectly spherical gyroscope. Certainly, this perfect gyroscope could improve navigation for airplanes, rockets and satellites. But Schiff (and independently, George Pugh in the Pentagon) proposed something else—a way to "see" local spacetime.

Schiff and Pugh suggested that if a near-perfect spinning gyroscope could be placed in spacetime, above the Earth and its spin axis precisely monitored, the floating gyroscope could show them the shape and behavior of our invisible spacetime frame. The experiment would only work with a near-perfect gyroscope, because Einstein's predicted effect of the curvature of spacetime around a body the size of Earth is microscopically small.

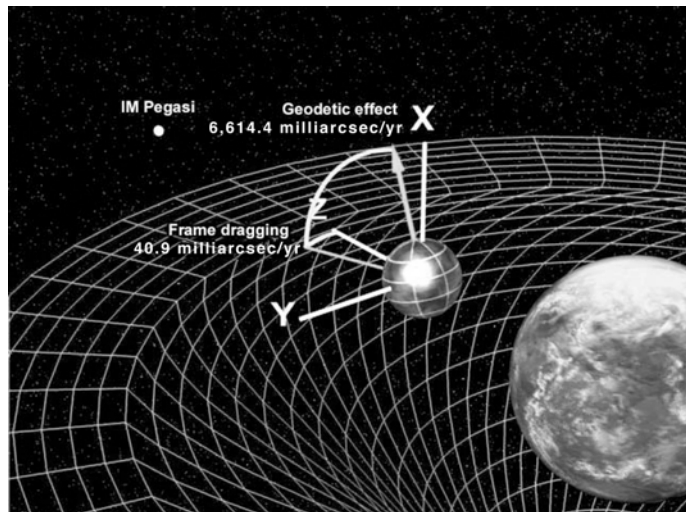

Why a gyroscope? Gyroscopes, or any spinning object, remain oriented in the same direction as long as they are spinning, a property called rotational inertia. A common example of this inertia is a spinning top. It balances on its end while spinning, yet topples over when friction slows it down. While it spins, its rotational inertia keeps it pointed straight up, oriented in its original direction.



Accordingly, if a top were spinning in the near-vacuum of space, it would remain constantly oriented in its original direction, since there would be no forces to slow it down. Our Earth is a prime example of this. The Earth's axis is oriented 23.5 degrees from vertical, relative to the Sun. It has remained in this position due in part to its rotational inertia.

If a perfectly-spherical, spinning gyroscope floated above the Earth in spacetime, and it was protected from external forces that could re-orient it (e.g., gravity, solar radiation, atmospheric friction, magnetic fields, electrical charges), and all internal imbalances were removed (e.g., imperfect shape, unbalanced density, surface imperfections) it would remain pointing in its original direction. The only thing that could alter its spin orientation would be the structure of spacetime itself.

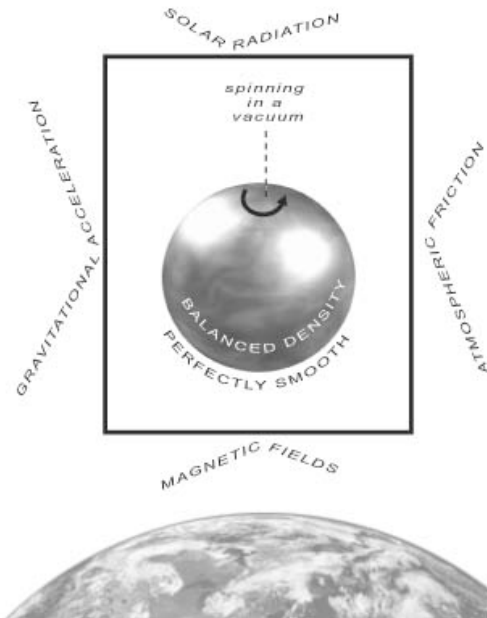

If the local spacetime in which the gyroscope was floating was curved or was twisting, the gyroscope's position would change to follow this curve or twist. If we could monitor this change in orientation, we could "see" the shape and behavior of spacetime itself. This is the mission of Gravity Probe B: to experimentally measure our local spacetime far more precisely than ever before.

The Mechanics of Gravity Probe B

The Gravity Probe B experimental design is as follows:

1. Place a satellite into polar orbit. Inside the satellite are four gyroscopes (GP-B uses four gyroscopes for redundancy) and a telescope.
2. Point the telescope at a distant star (called the "guide star"). GP-B aligns the telescope by turning the satellite because the telescope is fixed within the satellite.
3. Align the gyroscopes with the telescope so that when they are spinning, each spin axis also points directly at the guide star.

4. Spin up the gyroscopes and remove any external forces (pressure, heat, magnetic field, gravity, electrical charges) so the gyroscopes will spin unhindered, in a vacuum within the satellite, and free from any influence from the satellite itself.
5. Monitor the spin orientation of the gyroscopes over 1-2 years. Keep the telescope (and the satellite) fixed on the guide star and measure any angles that open up between the telescope's orientation and each gyroscope's spin axis. If local spacetime around the Earth is curved and frame-dragging occurs, the spin axis of the gyroscopes should slowly drift away from the starting point during this time, revealing the shape and motion of spacetime around the Earth.

According to Schiff's and Pugh's calculations, with the gyroscopes and satellite orbiting 400 miles (640 km) above the Earth's surface, the orientation of each gyroscope's spin axis should drift 6,614.4 milliarcseconds (or 6.6 arcseconds) per year in the orbital plane of the satellite, due to the curvature of Earth's local spacetime, and their spin axes should drift 40.9 milliarcseconds per year in a perpendicular plane (that is, the plane of Earth's rotation), due to the frame-dragging effect. In other words, Gravity Probe B intends to use gyroscopes and a telescope orbiting above Earth to measure two microscopic angles, each predicted to be a very tiny fraction of a single degree.

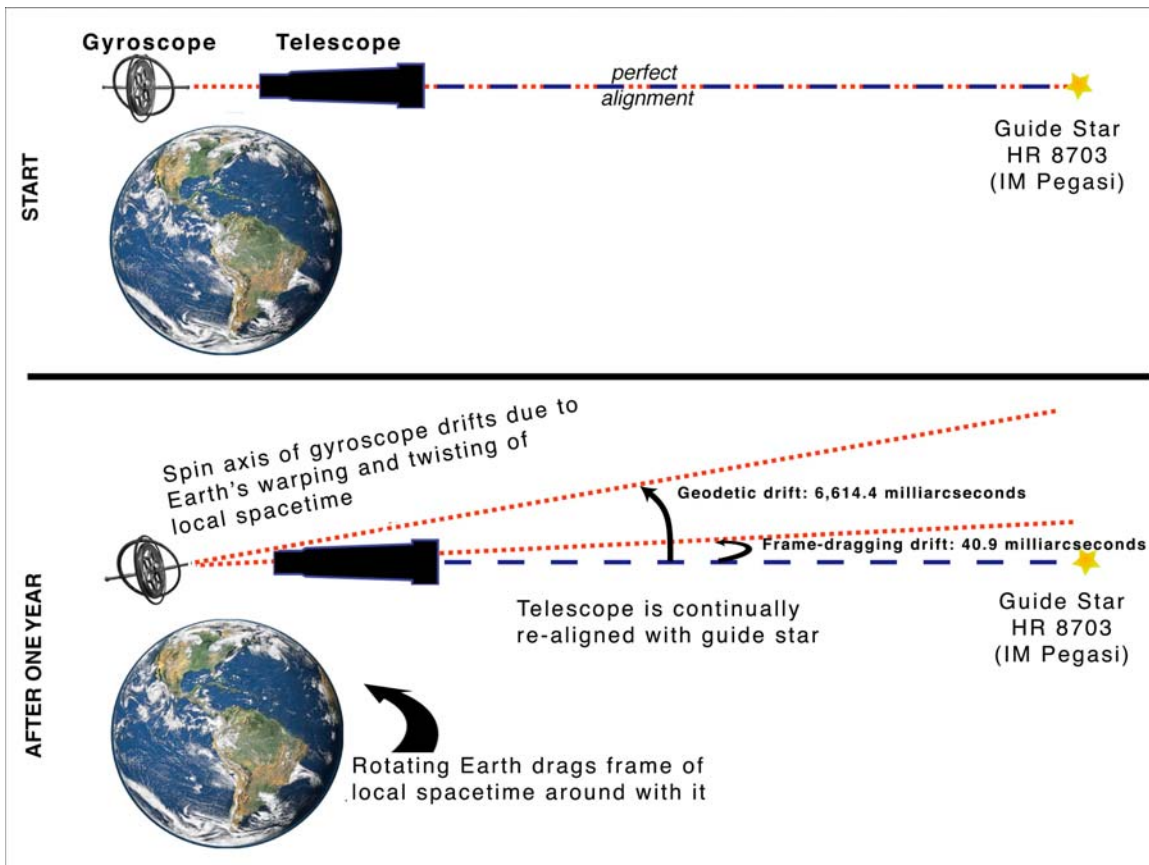

Redefining the Meaning of Precision

The central challenge of the Gravity Probe B mission is to build gyroscopes, a telescope, and a satellite that can precisely measure two minuscule angles—6,614.4 milliarcseconds (6.6 arcseconds) and 40.9 milliarcseconds. Because these angles are so small, GP-B has very little margin for error. GP-B must measure the shape and motion of local spacetime to within 0.5 milliarcseconds.

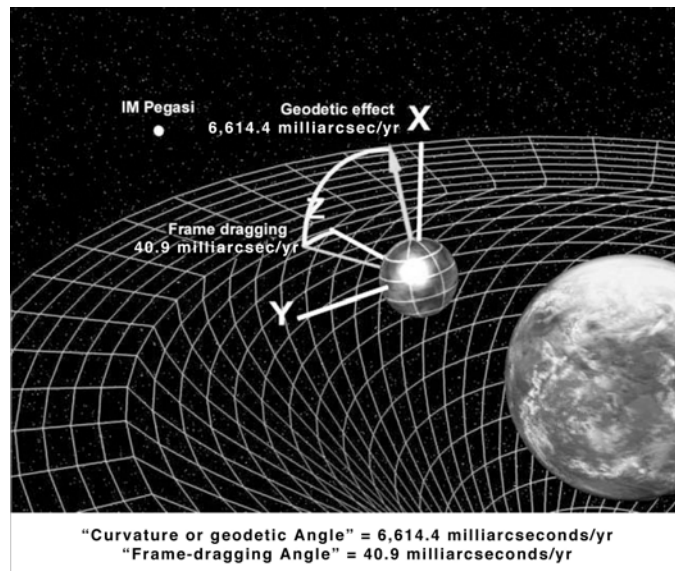

These angles are almost too small to comprehend. To visualize GP-B's minuscule angular measurements, imagine pointing a pencil. Then, raise it very slightly, moving it just one-half milliarcsecond from its original position. This is like trying to move your pencil:

- From one side to the other of a strand of hair twenty miles away.
- From the top to the bottom of Lincoln's face on a penny 3,000 miles away.
- From the foot to the head of a short astronaut standing on the Moon.

Alternatively, think of a round clock face. Each minute mark is six degrees apart. Within that space between the minute marks, there are 21,600 arcseconds, or 21.6 million milliarcseconds. Gravity Probe B must be able to measure an angle one-half as wide of one of those milliarcseconds—an angle nearly five-hundred million times smaller than the angle between minute marks on a clock face.

How Small is a Milliarcsecond?

One degree = 60 arcminutes'

One degree = 3,600 arcseconds

One degree = 3,600,000 milliarcseconds

One arcsecond = 0.000278 degrees
(~ 1/4000th of a degree)

One milliarcsecond = 2.78 x 10⁻⁷ degrees
(~ 1/4,000,000th of a degree)

The Space Vehicle

All of the Gravity Probe B technologies are integrated into one of the most elegant and sophisticated satellites ever to be launched into space. Over four decades in development, the GP-B space vehicle is a marvel of engineering and truly a beautiful sight to behold.



From its largest to smallest parts, it is filled with the cutting edge technologies and materials described in the previous section, many of which were invented specifically for use in the Gravity Probe B mission.

Inside the Dewar

A Dewar is a sophisticated Thermos bottle for holding cryogenic liquids. The Gravity Probe B Dewar will be one of the largest and most sophisticated ever put into space. It is nine-feet tall and forms the main structure of the space vehicle. The vacuum area just inside the Dewar's shell contains multiple reflective surfaces that cut down on heat radiation. The Dewar also contains vapor-cooled metal shields that help maintain its internal cryogenic temperature and slosh baffles that help suppress tidal motions in the superfluid helium inside. When cooled to almost absolute zero temperature, liquid helium transforms into a state called "superfluid," in which it becomes a completely uniform thermal conductor. Only helium exhibits this, and other special properties of superfluidity.

Inside the neck area of the Dewar is a doughnut-shaped tank called the "guard tank." Once the Dewar has been conditioned for launch—an iterative process of successive evacuations and fills that transforms the liquid helium inside the Dewar to the superfluid state—the guard tank keeps the Dewar supercooled for weeks,

without the need for additional conditioning, while the space vehicle is being readied for launch.

The Gravity Probe B Space Vehicle

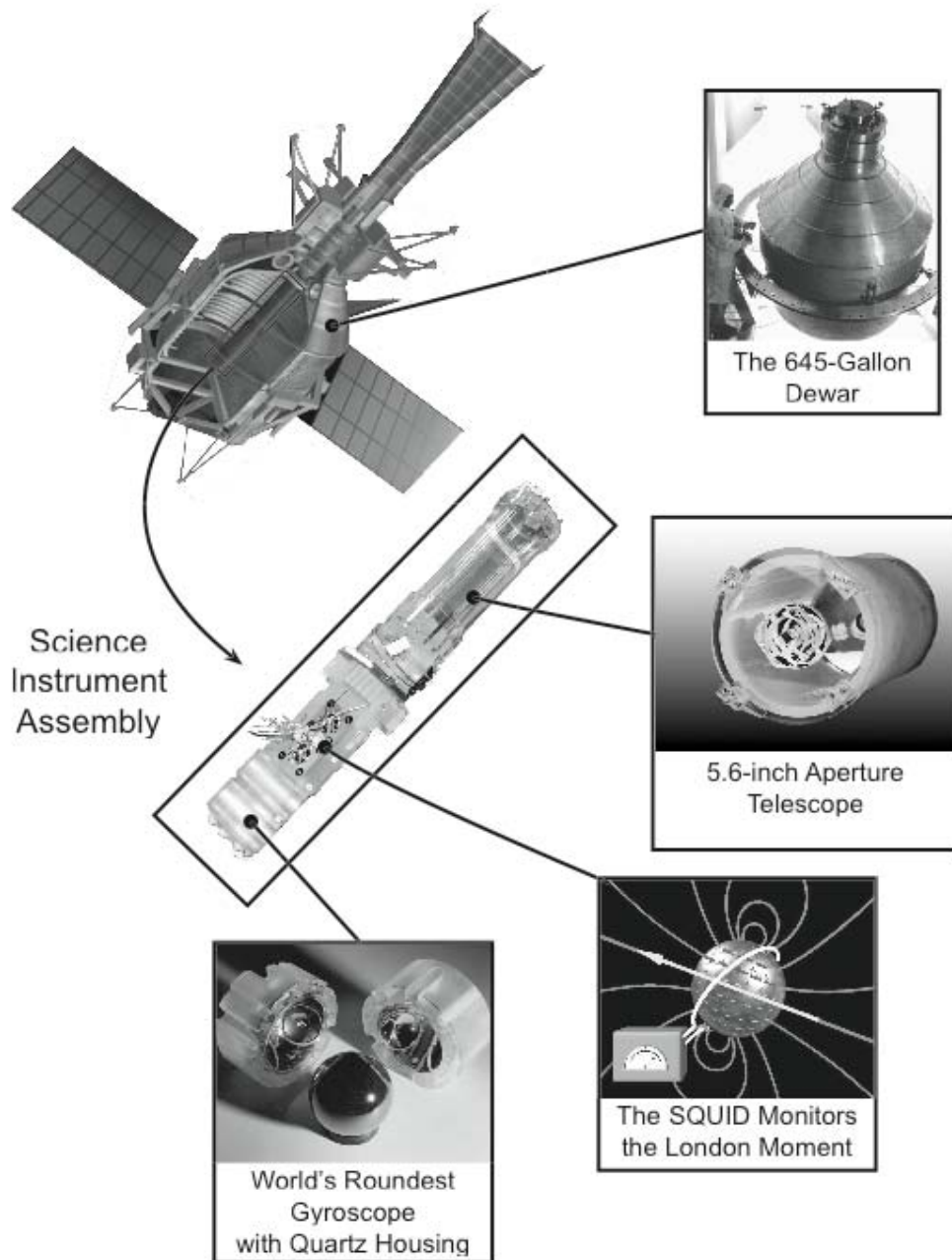

Science Instrument Assembly—Quartz Block and Telescope

The Science Instrument Assembly (SIA) contains the quartz block and the telescope. The SIA is located at the center of mass of the Dewar, along its main axis. It is mounted inside a vacuum canister called the probe (described in the next section).

The quartz block houses the four gyroscopes and SQUID readout instruments (Super Conducting Quantum Interference Devices—the magnetometers that read the gyroscopes' spin axis orientation). Each gyroscope is enclosed in a quartz clamshell housing, mounted in the quartz block and surrounded by antimagnetic shielding. The gyroscopes are electrically suspended with only 0.001 inch clearance from the housing walls, and they spin at up to 10,000 rpm during the science phase of the mission.

Optically bonded to the top of the quartz block is the quartz reflecting Cassegrain astronomical telescope, which focuses on the guide star, IM Pegasi. Optical bonding is a patented method of fusing together quartz parts, without the use of any “glue” or fasteners to ensure that the SIA does not distort or break when cooled to cryogenic temperatures. The line of sight of the telescope is rigidly aligned to the SQUID readout loop of each gyroscope. As such, the quartz telescope provides the frame of reference for measuring any drift in the spin axis of the gyroscopes.

The Probe

The SIA is mounted in a cigar-shaped canister, called the “probe,” which is inserted into the Dewar. The probe is an amazing feat of cryogenic engineering, designed by Lockheed Martin Space Systems in Palo Alto, California. It provides both mechanical and structural stability for the SIA. The probe is designed to provide a free optical path for the telescope to view distant space through a series of four windows, mounted in its upper section. These windows also serve to reduce thermal conductivity into the Dewar.

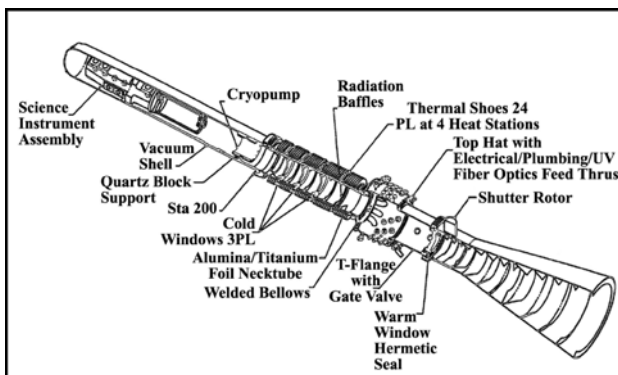

The inside of the probe is maintained at an extremely high vacuum—much greater than the vacuum of space. The probe is surrounded by a superconducting lead bag between it and the Dewar. The superconducting lead bag provides an impenetrable shield from electromagnetic signals that could disturb the gyroscopes.

Taken together, all of these measures create an ultra pristine, cryogenic environment, free of any external forces or disturbances, in which the gyroscopes spin.

At the upper end of the probe, capping the Dewar, is the “top hat.” The top hat serves as a thermal interface for connecting over 450 plumbing and electrical lines, that run from various electronics and control systems, mounted on the space vehicle’s truss system outside the Dewar, to the cryogenic vacuum chamber inside the probe and Dewar.



off

Before Gravity Probe B was completely integrated, each component went through years of testing and construction. Some parts even had to be de-constructed and rebuilt. The entire probe was assembled in a Class-10 clean room, as any particles larger than a single micron would disrupt the precise structure.

Outside the Dewar

Outside the Dewar are all of the systems that provide power, navigation, communication, and control of the space vehicle.

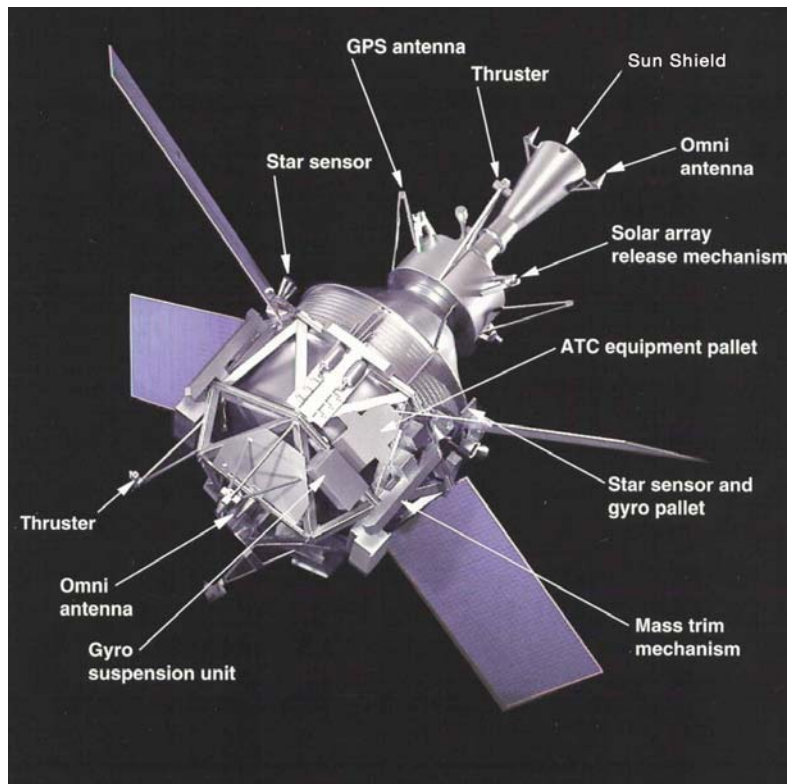

Sun Shield

The sun shield is a long, conical tube that keeps stray light from entering the telescope. Inside the sun shield are a series of black, metal baffles that absorb incoming stray light before it can reach the telescope. In addition to blocking out stray light from the Sun, the sun shield also blocks stray light from the Earth, Moon, and major planets.

Proportional Micro Thrusters

The proportional micro thrusters on the space vehicle provide a very means of controlling its attitude or orientation in space. In the case of Gravity Probe B, an unprecedented amount of on-orbit control is required for the vehicle to maintain its drag-free orbit. This is accomplished by harnessing the helium gas that continually evaporates from the Dewar's porous plug and venting it as a propellant through eight pairs of opposing or balanced proportional micro thrusters.

These micro thrusters continually meter out a flow of helium gas—at the rate of about 1/100th the amount of a human “puff” exhalation that one might use to clean eyeglasses. This metered flow of helium keeps the space vehicle's center of mass balanced around one of the gyroscopes, called a “proof mass”—a predetermined test mass that serves as a reference for measurement. The thrusters are set up in pairs, so that they counterbalance each other. As long as the same amount of helium is flowing from two opposing thrusters, the space vehicle will not change its position along that axis. However, if the telescope or the SQUID readout for the proof mass gyroscope requires the space vehicle's position to change, it is simply a matter of unbalancing the flow, ever so slightly, in the appropriate thruster pair to move the vehicle in the desired direction. These proportional micro thrusters also control the roll rate of the GP-B space vehicle.

Solar Arrays

Solar arrays convert energy from the Sun into electrical power that is stored in the space vehicle's two batteries and then used to run the various electrical systems on board. The position of each solar array can be controlled to maximize its power output.

GPS Sensors & Antennae

GPS (Global Positioning System) sensors calculate and transmit information about the space vehicle's position. In the case of the Gravity Probe B space vehicle, the number and placement of the GPS sensors provide positioning information that is over 100 times more accurate than traditional ground-based GPS navigation systems. For example, a high quality handheld GPS sensor on Earth can locate your position to within about a meter, whereas the GPS sensors onboard the GP-B space vehicle can locate its position to within a centimeter.

Telemetry & Communications Antennae

These antennae enable both inbound and outbound communications with the space vehicle—this includes communications with ground stations and with orbiting communications satellites in the Tracking Data Relay Satellite System (TDRSS). Telemetry data from the space vehicle and science data from the experiment are transmitted to ground stations using these communications systems. These systems also enable the GP-B Mission Operations Center (MOC) to send daily batches of commands to the space vehicle. Communications between the space vehicle and orbiting satellites is limited to a 2K data format, whereas communications with ground stations uses a 32K data format, enabling far more data to be transmitted per unit of time.

Star Trackers

A star tracker is basically a camera and pattern matching system that uses constellations and stars to determine the direction in which a satellite is pointing. The Gravity Probe B satellite contains two star trackers—one wide field and one narrow field (called the star sensor). The wide field star tracker is used to locate the general region of the heavens containing the guide star, and then the narrow field star tracker helps align the space vehicle with the guide star.

The Gravity Probe B on-board telescope basically performs the same function, but it uses a different technique, and it is orders of magnitude more precise and more accurate. The narrow field star tracker has a field of view on the order of one degree (60 arcminutes), and it can focus to a position within perhaps one arcminute—about the same as the whole field of view of GP-B on-board telescope, which can pinpoint the guide star's position to within a milliarcsecond.

With such a small field of view, it would be nearly impossible to locate the guide star using only the onboard telescope, so the star trackers function like “spotting scopes” for initially pointing the space vehicle towards the guide star. Once the narrow field star tracker has focused on the guide star, the onboard telescope takes over the job of maintaining the precise alignment required for measuring gyroscope drift.

Navigational Gyroscope

GP-B uses a standard, flight-qualified gyroscope, equivalent to those found on other spacecraft (and also airplanes, ships, and other vehicles). This gyroscope is not part of the relativity experiment, but rather it is part of the general navigation system used for monitoring the general direction and position of the space vehicle.

Electro-mechanical Control Systems

Surrounding the Dewar, is a lattice of trusses that forms the structure of the space vehicle. Attached to these trusses are a number of electrical and mechanical systems that control the operation of space vehicle and enable the relativistic measurements to be carried out. These control systems include the following:

- **Attitude Control System (ATC)**—Controls all of the proportional micro thrusters that determine and maintain the space vehicle's precise positioning.
- **Mass Trim Mechanism (MTM)**—A system of movable weights that can be adjusted during flight to restore rotational balance of the space vehicle (similar to spin balancing the tires on an automobile)
- **Gyro Suspension System (GSS)**—The electronics that levitate and precisely control the suspension of the four gyroscopes at the heart of the Gravity Probe B experiment. The GSS control boxes are mounted in the truss work, outside the Dewar. The wiring goes through the top hat section of the probe and down to each gyroscope.
- **Gas Management Assembly (GMA)**—A very complex set of valves, pipes, and tubing, that runs from a triangular assembly on the truss work, through the top hat and down the probe to each of the gyroscopes. The critical job of the GMA is to spin up each of the four gyroscopes by blowing a stream of 99.99999% pure helium gas over them, through a channel built into one half of each gyroscope's quartz housing.
- **Experiment Control Unit (ECU)**—The ECU controls many of the systems onboard the space vehicle, including the GMA, the UV system, and various thermal devices.

The Mission

Mission Overview

The purpose of the Gravity Probe B Relativity Mission satellite is to measure two relativistic effects on nearly perfect gyroscopes. Both of these effects are precisely predicted by Einstein's general theory of relativity, and the gyroscope measurements are an experimental test of two predictions of the theory:

- 1) The geodetic effect, which is due to the gravitational interaction of the spinning gyroscope and its orbital angular momentum about the earth
- 2) The frame-dragging effect, which is due to the gravitational interaction between the spinning gyroscope and the angular momentum of the earth.

The geodetic effect is predicted to cause a drift rate of 6,614.4 milliarcseconds (6.6 arcseconds) per year in the plane of the orbit for a gyroscope in a 650 km (400 mile) circular orbit, and the frame-dragging effect is predicted to cause a drift of 40.9 milliarcseconds per year in a direction perpendicular to the plane of the orbit.

The requirement for the overall accuracy of the Gravity Probe B Experiment is to measure the drift rate of each of the four gyroscopes to an accuracy of 0.5 milli-arcseconds per year. At this level, the frame-dragging effect will be measured to an accuracy of 1%, and the geodetic effect will be measured to an accuracy of 1 part in 10,000. A measurement of the drift rate of the gyroscopes at this level of accuracy will be the most accurate non-null experimental test of general relativity ever made. Present estimates of the overall accuracy of the experiment indicate that it will be possible to measure the drift rates significantly better than 0.5 milliarcseconds per year.

The GP-B Space Vehicle will be launched from the Vandenberg Launch Facility at Vandenberg Air Force Base (VAFB) in California. GP-B will be launched on a Delta II 7920-10 rocket from launch pad SLC-2W into a polar circular orbit of 640 km (400 mile) altitude. The Space Vehicle is launched with the Command/Control Computer Assembly, Command and Data Handling subsystem, and Attitude Control Electronics powered on; command and telemetry links should be established from the Mission Operations Center (MOC) at Stanford University as soon as the fairing separates—about 5 minutes after launch. The Launch Vehicle will release the Space Vehicle in the desired attitude and at the desired roll rate. Solar arrays are deployed soon after launch.

The Space Vehicle is configured for science mission operations during the Initial Orbit Checkout (IOC) phase, which is scheduled for the first 40-60 days after launch. Many important things happen during IOC. Subsystem boxes are powered on and verified. As soon as the orbit is determined, the Attitude and Translation Control

subsystem (ATC) is commanded to begin making the necessary orbit corrections. The low thrust of the propulsion system requires that corrections be started as soon as possible so that the correction doesn't delay the start of the science mission. The attitude is confirmed using the telescope. The science gyros are turned on and SQUIDs tested. The drag free operation of the spacecraft is tested and verified, and the spacecraft is balanced using the mass trim mechanisms. Calibrations are made, and the gyros are spun up. The orbit is finalized, the spacecraft rebalanced, and gyros are then precisely set for nominal science operations. The 60-day initialization schedule contains 20 days of contingency, and funding allows for an additional 15 days if required.

During the Space Vehicle configuration, operations will be 24 hours a day, 7 days a week. Four to six Ground Network tracks will be scheduled each day for high data rate return. Several hours of Space Network Tracking Data Relay Satellite System (TDRSS) tracking will provide large windows for commanding the Space Vehicle during this period.

Once the spacecraft and payload are configured, with the gyros suspended and spinning, and the ATC autonomously providing attitude and drag-free orbit control, the science mission begins. Nominally three to four Ground Network tracks per day will allow a daily upload to the flight computer to control the spacecraft and payload configuration and return data. Occasional data base updates may be made. The space Network TDRSS will provide two passes a week for orbit determination and as required for contingency operations.

When it is determined that there is only a 1-2 months of helium left to maintain the required superconducting temperatures, the mission will shift to the post science calibration phase. During this phase, recalibrations will be performed and intentional disturbances will be introduced to ensure that the flight data is well understood and valid. The nominal total mission time is 18 months.

Launch Site & Vehicle

The spacecraft will be launched from Vandenberg Air Force Base, CA, on a Delta II 7920-10 launch vehicle. Overall, the rocket is 38.6 meters (126.5 feet) long, 3 meters (10 feet) in diameter and weighs 231,821 kilograms (511,077 pounds or 255.5 tons). It has nine strap-on solid rocket motors. The Delta's first stage burns kerosene and liquid oxygen propellant, and produces 890,000 newtons (200,000 lbs.) of thrust. The second stage burns hydrazine and nitrogen tetroxide propellant, producing a thrust of 43,400 newtons (9,750 pounds).

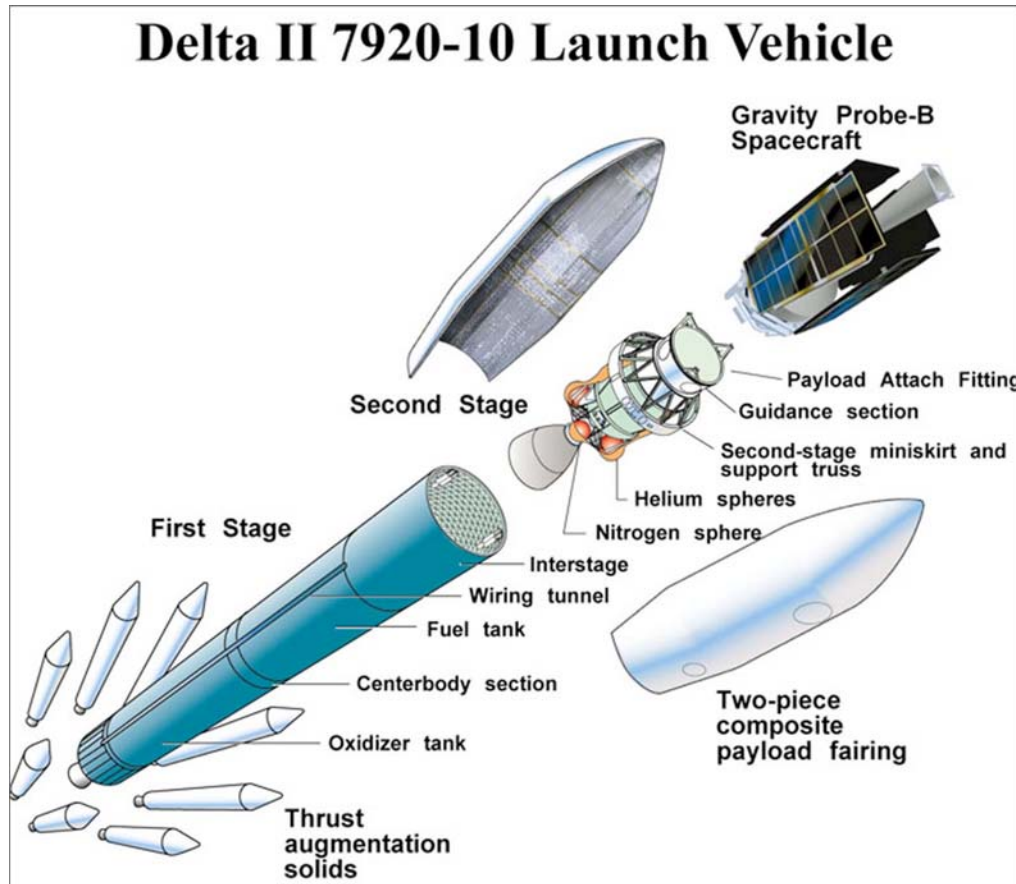

Nominal Orbit

The nominal orbit is defined by the following, as measured at the first ascending node (Earth Centered, Earth Equator, Inertial of 2000):

- Semi-major axis 7027.4 km
- Eccentricity 0.0014
 - Apogee altitude 659.1 km
 - Perigee altitude 639.5 km
- Inclination 90.007°
- Argument of Perigee 71.3°
- Right Ascension of Ascending Node 163.26°
- True Anomaly 288.7

Launch Period

The daily launch period opens on Saturday, April 17, 2004. If launch does not take place then, GP-B can be prepared to launch on two consecutive days, but needs each third day for re-servicing of its helium guard tank.

Launch opportunities from April 17-21 will use an inclination of 90.011 degrees; from April 22-30, the inclination would be 90.007. Both inclinations are almost due South.

Daily Launch Time

There is one 1-second launch opportunity each day during the launch period. On April 17, the launch time is at 10:09:12 a.m. PDT. (On April 18 and later, the launch time is earlier by almost 4 minutes a day.

Television Coverage

The Delta rocket will carry two video cameras, which will record the separation of the 2nd stage of the launch vehicle from the GP-B Space Vehicle.

Mission Operations

Mission operations will be conducted from the Gravity Probe B Mission Operations Center (MOC), located in the Gravity Probe B building at Stanford University, Stanford, California. Spacecraft communications will be conducted through NASA's Space Network (TDRSS).

Mission Time Line

This mission time line is divided into four main phases:

- 1) Launch and Early Orbit (L&EO) Phase
- 2) Initialization and Orbit Checkout (IOC) Phase
- 3) Science Phase
- 4) Post-science Calibration Phase.

Each of these phases is described in more detail below.

Launch and Early Orbit Phase

This phase covers the period of time immediately prior to launch through the first day of flight operations. The Gravity Probe B space vehicle will lift on a Delta II 7920-10 rocket from launch pad SLC-2W at Vandenberg AFB, CA. into a polar circular orbit of 640 km (400 mile) altitude.

The Delta's main engine cutoff will occur at about 263 seconds. The second stage engine will ignite about 277 seconds, and cut off for the first time at about 11 minutes after launch. After coasting, the second stage will restart at launch plus about 62 minutes, and will burn for about 16 seconds. At 75 minutes after launch, the Gravity Probe B Space Vehicle will separate from the second stage. The second stage will perform a maneuver to move away from the Space Vehicle to avoid future contact and possible contamination. After separation from the second stage, the Space Vehicle will orient itself towards the guide star.

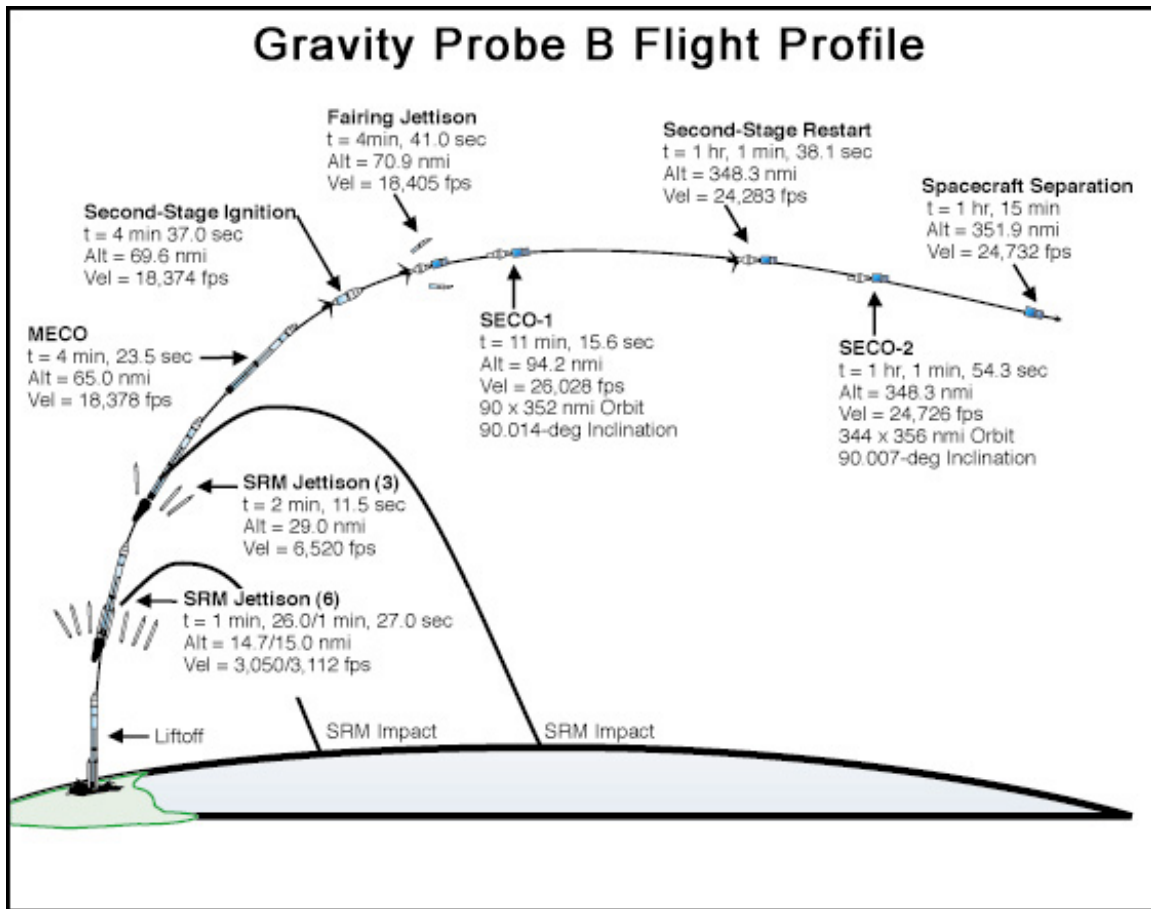

The Mission Operations Center (MOC) at Stanford University will be able to command and monitor telemetry from the space vehicle at VAFB. The baseline plan is for the pre-launch stored program commands and launch time to be loaded by the computers at the launch site, with telemetry monitoring at the MOC. As soon as the fairing separates, the stored program commands will power on the space vehicle

transmitter, starting a telemetry link through a tracking data relay satellite (TDRS) to the MOC. Commanding is also possible at this time, if required.

The nominal timeline below summarizes the main events of the launch and early orbit mission phase.

Gravity Probe B — Launch & Early Orbit Nominal Timeline

Time from Launch	Event
0	Launch on Delta II at VAFB
48 sec	Maximum Dynamic Pressure
1 min 26-27 sec	First 6 solid rocket booster motors separate
2 min 12 sec	Last 3 solid rocket booster motors separate
4 min 24 sec	Main Engine Cutoff (MECO)
4 min 31 sec	Stage II separates from Stage I
4 min 37 sec	Stage II ignition
4 min 41 sec	Jettison Fairing
5 min 5 sec	Power on star sensors; set Attitude Control (ATC) I/O directives
11 min 16 sec	First Cutoff — Stage II (SECO-1)
1 hr 1 min 38 sec	Stage II Restart Ignition (orbit circularization)
1 hr 1 min 54 sec	Second Cutoff — Stage II (SECO-2)
1 hr 6 min 50 sec	Begin solar panel deployment
1 hr 11 min 40 sec	End solar panel deployment
1 hr 15 min 0 sec	GP-B Spacecraft separation from Stage II
1 hr 15 min 1-42 sec	Stage II Retro
1 hr 16 min 37 sec	Begin attitude capture
1 hr 17 min 32 sec	Enable survival heaters for battery, ECU, SRE, & GSS
1 hr 26 min 43 sec	GPS Side A/B power on
1 hr 31 min 45 sec	Third Cutoff — Stage II (SECO-3)
1 hr 38 min 20 sec	Restart 3 — Stage II
1 hr 44 min 19 sec	Aft SQUID Readout Electronics (SRE) power on
1 hr 57 min 18 sec	Electronic Control Unit A (ECU-A) power on
5 hr 0 min 6 sec	Proton Monitor on
5 hr 9 min 6 sec	Telescope Detectors on
6 hrs 33 min 28 sec	Gyro Suspension System 2 (GSS-2) power on

Initialization and Orbit Checkout (IOC) Phase

The IOC phase is planned to last between 40 and 60 days. Payload activities during this phase of the mission include calibration and measurements of on-orbit performance of the payload instrumentation and uncaging, levitation, and a slow spin (~1 Hz) of the gyroscopes. Spacecraft activities include deployment of the solar arrays, acquisition of the guide star, and final orbit trim. During this phase extensive testing of the on-orbit performance will require frequent commands to the spacecraft and careful evaluation of the telemetry. The initialization phase will conclude when the gyroscopes are spun up to full speed and aligned with the satellite roll axis and the satellite is commanded to its main science phase roll rate. The table below provides a nominal timeline of the IOC activities.

Gravity Probe B — Nominal Timeline of IOC Activities

Time From Launch	Activity
2 hours	Dewar vent, Orbit Acquisition (Completion of task)
1 day	Start Orbit trim (Completes many days later)
2 days	Power-On and Set-Up Of Payload Electronics Boxes
2 days	Flux lock SQUIDs
2 days	Guard tank runs out of helium
2 days	Acquire guide star (Confirmation: 4 days)
3 days	Drag Free (Gyro #2 acts as "proof mass")
8 days	Gyro checkout: Low voltage on 4 gyros, High voltage gyro 3
10 days	Start Dewar pressure control
18 days	Mass Trim Sequences (balancing vehicle) Completed
18 days	Space Vehicle Spin Up & Helium Bubble Wrap
20 days	Trapped flux measurement/reduction/re-measurement
22 days	1 Hz spin all gyros (plus High Voltage check gyros 1, 2, 4)
23 days	5 Hz spin gyros 3, 4
31 days	Gyro health check, practice spin alignment & post science calibrations completed
32 days	5 Hz spin gyros 1, 2
36 days	High speed spin gyros 4, 3, 1, 2
38 days	Spin axis alignment polarity
43 days	Spin axis alignment completed
43 days	Low Temperature Bakeout
44 days	Transition to Science Phase of Mission

Following is a more detailed description of the main IOC activities.

Orbit Trim Maneuver (L+1 Day)

Because the launch vehicle does not place the space vehicle exactly into the orbit plane required for the science phase of the mission, it will be corrected during IOC. Ground generated command parameters will be used to automatically command thruster firings. The orbit trim process includes review of orbit data as determined by Doppler and GPS data, calculation of the required parameters for the orbit trim flight software, transmission of these parameters, and initiation of the automatic orbit trim maneuver. For large (3-sigma) launch errors, the time required to correct planar errors may be the longest activity in the IOC phase, so an early determination of the launch orbit and initiation of its correction will be important. Nominally, orbit correction sequences are expected to begin within 24 hours after achieving orbit. A one-sigma error can be corrected in 10-14 days.

Guide Star Acquisition (L+2 Days)

About 24 hours after launch, the flight software automatically begins the process of acquiring the guide star. No real-time commanding or special telemetry requirements are expected to complete this activity, although the sequence can be broken into steps requiring initiation commands from the ground, if required. Guide star acquisition consists of determining the initial attitude using the star sensors, measuring gyro biases, performing a coarse attitude maneuver using thrusters, and then refining the attitude based on data from the onboard science telescope.

Mass Trim Sequences (Completed L+18 Days)

After launch, the center of mass and products of inertia of the space vehicle can be corrected by moving some or all of the seven mass trim mechanisms (MTM). The process to operate the MTMs includes analysis on the ground of ATC data (to see what forces and torques are required to hold attitude), generation of commands, and then execution of special mass trim sequences. The baseline timeline shows several MTM events throughout the IOC period to allow refinement of the mass properties, beginning with a coarse trim on day 6. Final mass trim cannot be completed until the vehicle is operating in drag-free mode. It is expected that mass trim refinements will be required occasionally throughout the mission as helium is depleted or thermal properties change.

Space Vehicle Spin Up / Helium Bubble Wrap (Completed L+18 Days)

The space vehicle is separated from the launch vehicle rolling at 0.1 rpm. During IOC the roll rate is sequentially increased to 1.0 rpm for two reasons:

- 1) Get better insight into adjusting the Mass Trim Mechanisms (MTM)
- 2) Mass balance the space vehicle by wrapping the liquid helium bubble uniformly around the Dewar chamber.

The space vehicle is then spun down to 0.6 rpm for the first gyro spin up interval. Just prior to commencing the science phase of the mission, the final roll rate will be determined and set (the value is expected to be between 0.3 rpm and 1.0 rpm).

Drag Free Operations (Starts L+ 3 Days)

Drag free operations are practiced beginning on Day 3 of IOC. Towards the end of IOC, the vehicle is commanded to fly drag free for the duration of the science phase of the mission. There is no real-time commanding required for this process. The Attitude Control Electronics (ACE) uses position data from science gyro #2, which has been designated as a “proof mass,” and commands the thrusters to maneuver the vehicle to maintain this gyro in the center of its housing.

Gyro Spin Up (Starts L+22 Days)

Spinning up the Gravity Probe B gyroscopes is a delicate and complex process that requires more than half of the IOC mission phase. Each of the four science gyros undergoes a series of four spin-up and testing sequences, gradually increasing its speed to the final spin rate required for the science phase of the mission.

The first spin up sequence involves using the Gyro Suspension System (GSS) to levitate and position each gyro—one at a time—in its nominal spin up position. For each gyro, the Gas Management Assembly (GMA), which flows ultra pure helium gas through the spin up channel in one half of the gyro’s housing, is operated; however no gas is flowed over the gyro during this first spin up sequence.

The second spin up sequence repeats the first one; however in this case, a small amount of gas is flowed over each of the gyros—again, one at a time. This results in each gyro reaching a spin rate of approximately 1 Hz (60 rpm).

In the third spin up sequence, the GMA flows a somewhat larger amount of helium gas over each gyro, resulting in a spin rate of approximately 5 Hz (300 rpm).

The fourth and final spin up sequence increases the gyro’s spin rate to full speed. This requires the GMA to flow helium gas over each gyro continually, for a period of 1-2 hours. At the conclusion of this sequence, each gyro will be spinning at up to 150 Hz (9,000 RPM).

Spin Axis Alignment (Starts L+38 Days)

After gyro spin up, the spin axis direction of each gyro must be closely aligned to the guide star. This is accomplished by torquing or twisting the rotor in a methodical manner, using the Gyro Suspension System (GSS) electronics. There are two phases to this alignment process—coarse and fine. During the coarse alignment, as much as one degree of spin axis orientation correction is achieved. The fine axis alignment then provides the final orientation accuracy of better than 10 arcseconds relative to the guide star.

Low Temperature Bakeout (L+43 Days)

Also following gyro spin up, is the low temperature bakeout process. The gyro spin up process leaves residual helium gas in and around each of the science gyros. If not removed, this helium would reduce the accuracy of the experimental data collected during the Science Phase of the mission. The low temperature bakeout process involves applying a *very* mild heat cycle to the Science instrument Assembly, briefly raising its temperature from 1.8 Kelvin to approximately 7 Kelvin. The net effect of this procedure is to remove nearly all of the residual helium. A cryogenic pump, comprised of sintered titanium in a sponge-like form, getters the remaining helium from the gyro housings. After low temperature bakeout, the SIA temperature is restored to 1.8 Kelvin.

Science Phase

After the gyroscopes are spun up to full speed, the mission enters a phase where the essential science data are collected. During this period there will be a minimal number of commands sent to the satellite, and the acquisition and telemetry of the data will follow a routine pattern. The telemetry during this phase will include health and safety data, basic science data, and additional data necessary for the evaluation of potential systematic experimental errors. This phase is expected to last between 13 and 15 months.

Post-Science Calibration Phase

An essential part of the mission is the post-science calibration phase where the disturbing torques on the gyroscopes and potential systematic measurement errors are deliberately enhanced. During this period, commands will be sent to the satellite more frequently. The information collected during this period will be used to place limits on the systematic experimental errors. This phase is expected to last between two and three months. Measurement of the remaining superfluid helium will be used to time the transition from the Science Phase to the Calibration Phase.

The Amazing Technology of GP-B

To test Einstein's theory of general relativity, Gravity Probe B must measure two minuscule angles with spinning gyroscopes, floating in space. While the concept of Gravity Probe B is relatively simple in design, the technology required to build it is some of the most sophisticated in the world. Scientists from Stanford University, NASA's Marshall Space Flight Center, and Lockheed Martin Space Systems have drawn from a diverse array of physical sciences, and have invented much of the technology that makes the mission possible. In fact, much of the technology did not even exist when Leonard Schiff (and independently, George Pugh) conceived of the experiment in the early 1960's.

The GP-B Science Instrument

The Gravity Probe B science instrument takes the shape of a long rectangular block with four gyroscopes lined up behind a telescope that peers out the top of the Gravity Probe B satellite. Each gyroscope is suspended in a quartz housing, surrounded by a metal loop connected to a SQUID magnetometer (Super Quantum Interference Device) to monitor its spin axis orientation. The fused quartz gyroscopes sit in a fused quartz block that is bonded to the fused quartz telescope. These three components make up the Science Instrument Assembly (SIA).

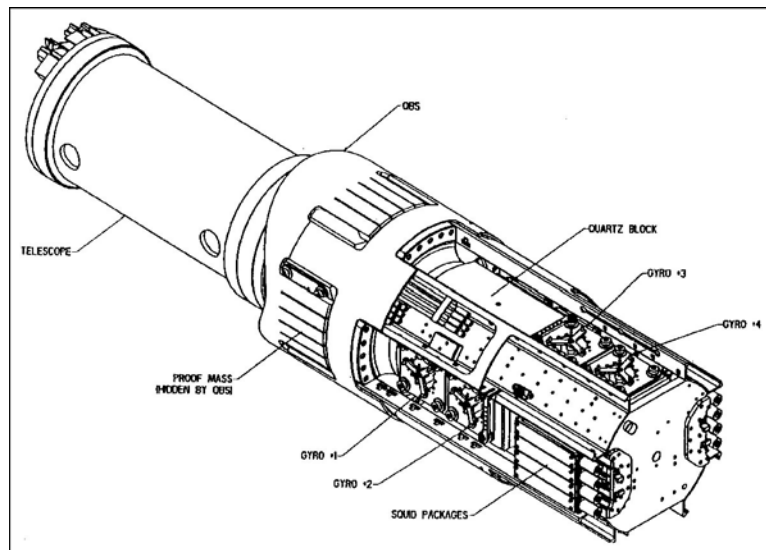

World's Most Perfect Gyroscopes

To measure the minuscule angles that Leonard Schiff and George Pugh predicted—6,614.4 milliarcseconds (6.6 arcseconds) per year and 40.9 milliarcseconds per year—Gravity Probe B needed to build a near-perfect gyroscope—one whose spin axis would not drift away from its starting point by more than one hundred-billionth of a degree each hour that it was spinning. This was an especially stiff challenge, given that the spin axes of all gyroscopes tend to drift slightly while they are spinning. Even the spin axis drift in the most sophisticated Earth-based gyroscopes, found in missiles and jet airplanes, is seven orders of magnitude greater than GP-B could allow.

Three physical characteristics of a gyroscope can cause its spin axis to drift:

- 1) An imbalance in mass or density distribution inside the gyroscope
- 2) An uneven, asymmetrical surface on the outside of the gyroscope causing air friction
- 3) Friction between the bearings and axle of the gyroscope.

This means the GP-B gyroscope has to be perfectly balanced and homogenous inside, cannot have any rough surfaces outside, and must be free from any bearings or supports.

After years of work and the invention of numerous new technologies, the result is a homogenous 1.5-inch sphere of pure fused quartz, polished to within a few atomic layers of perfectly smooth. It is the most spherical object ever made, topped in sphericity only by neutron stars.

Inside, the gyroscope is solid fused quartz. It was carved out of a pure quartz block grown in Brazil and then baked and refined in a laboratory in Germany. Its interior parts are all identical to within two parts in a million.

On its surface, the gyroscope is less than three ten-millionths of an inch from perfect sphericity. This means that every point on the surface of the gyroscope is the exact same distance from the center of the gyroscope to within 0.0000003 inches.

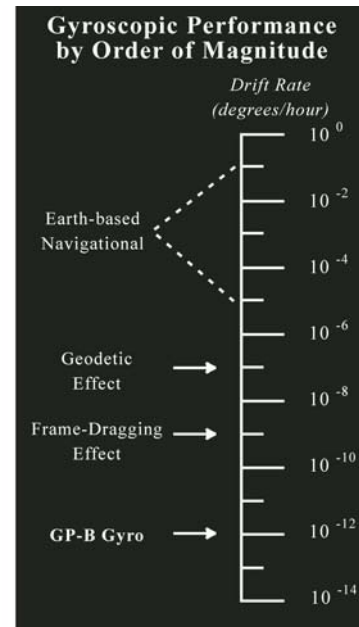

Here are two ways to imagine how smooth this is. First, compare the GP-B gyroscope's smoothness with another smooth object—a compact disk. CD's and DVD's both appear and feel incredibly smooth. The pits on the compact disk's surface, which carry the digital information, are less than 4/100,000ths of an inch deep (one millionth of a meter). However, compared to the GP-B gyroscope, the surface of a CD is like sandpaper. The bumps and valleys on the surface of the GP-B gyroscope are 100 times smaller than those on a CD. Viewed at the same

magnification, one could barely see any imperfections on the gyroscope's surface.

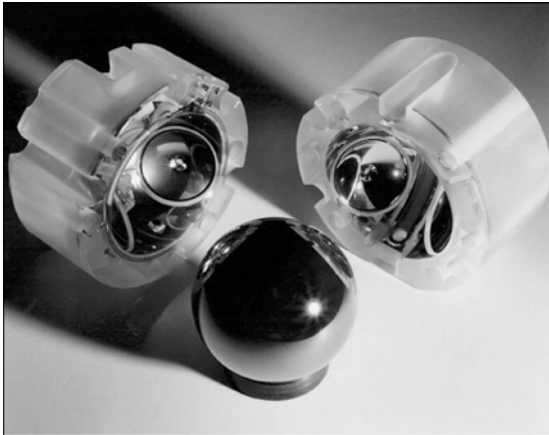

Gravity Probe B gyroscope (rotor), with quartz housing halves.

Each glass-like rotor is coated with a sliver-thin layer of niobium, a superconducting metal. Inside each housing, six electrodes electrically suspend the gyroscope, allowing it to spin freely at up to 10,000 rpm. Channels are cut in the quartz housing to allow helium gas to start the rotor spinning. A wire loop, embedded in the housing, acts as a SQUID (Superconducting Quantum Interference Device) to detect any change in direction of the gyroscope's spin axis.

Alternatively, imagine a GP-B gyroscope enlarged to the size of the Earth. On Earth, the tallest mountains, like Mount Everest, are tens of thousands of feet high. Likewise, the deepest ocean trenches are tens of thousands of feet deep. By contrast, if a GP-B gyroscope were enlarged to the size of the Earth, its tallest mountain or deepest ocean trench would be only eight feet!

Finally, the gyroscope is freed from any mechanical bearings or supports by levitating within a fused quartz housing. Six electrodes evenly spaced around the interior of the housing keep the gyroscope floating in the center. A brief stream of helium gas spins the gyroscope up to 10,000 rpm. After that, the gyroscope spins in a vacuum, a mere 0.001 inches from the housing walls, free from any interfering supports.

Spinning Superconductivity

Each Gravity Probe B gyroscope is nearly perfectly spherical and nearly perfectly homogenous. While this ensures that the gyroscope will spin with near-perfect stability, its "near-perfect-ness" creates a daunting challenge—GP-B scientists cannot mark the gyroscope to see exactly which direction its spin axis is pointing.

For GP-B to "see" the shape and motion of local spacetime accurately, the scientists must be able to monitor the spin axis orientation to within 0.5 milliarcseconds, and spot the poles of the gyroscope to within one-billionth of an inch.

How can one monitor the spin axis orientation of this near-perfect gyroscope without a physical marker showing where the spin axis is on the gyroscope? The answer lies in a property exhibited by some metals, called “superconductivity.”

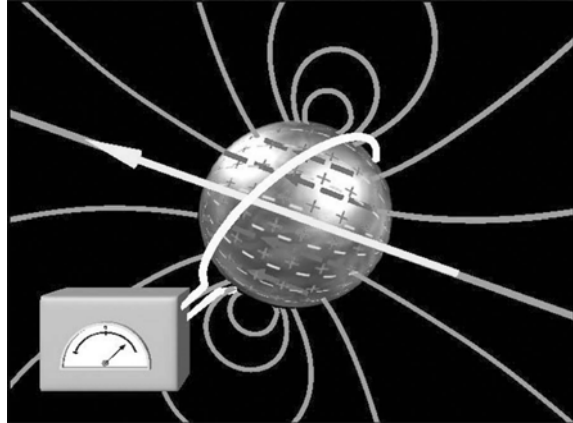

Superconductivity was discovered in 1911 by the Dutch physicist H. Kammerlingh Onnes. He found that at temperatures a few degrees above absolute zero, many metals completely lose their electrical resistance. An electric current started in a superconductor ring would flow forever, if the ring were permanently kept cold. But, superconductors also have other interesting properties. In 1948, the theoretical physicist Fritz London predicted that a spinning superconductor would develop a magnetic moment, exactly aligned with its instantaneous spin axis. In 1963, three different groups, including a GP-B graduate student, demonstrated the existence of this London moment experimentally.

What is remarkable about this phenomenon (and most fortunate for Gravity Probe B) is that the axis of this magnetic field lines up exactly with the physical axis of the spinning metal. Here was the “marker” Gravity Probe B needed. GP-B scientists coated each quartz gyroscope with a sliver-thin layer of a superconducting metal, called niobium (1,270 nanometers thick). When each niobium-coated gyroscope rotates, a small magnetic field surrounds each gyroscope. By monitoring the axis of the magnetic field, Gravity Probe B knows precisely which direction the gyroscope’s spin axis is pointing.

The magnetic field axis is monitored with a special device called a SQUID (Superconducting QUantum Interference Device). The SQUID is connected to a superconducting loop embedded within the quartz housing. When the gyroscope tilts, the London moment magnetic field tilts with it, passing through the superconducting loop. The SQUID detects this change in magnetic field orientation. The SQUID is so sensitive that a field change of 5×10^{-14} gauss (1/10,000,000,000,000th of the Earth’s magnetic field), corresponding to a gyro tilt of 0.1 milliarcsecond, is detectable within a few days.

Using the London moment to monitor the gyroscope’s orientation is the one readout scheme perfect for Gravity Probe B: extremely sensitive, extremely stable, applicable to a perfect sphere, and—most importantly—exerts no reaction force on the gyroscope at all.

Cement Mixer-sized Thermos Bottle

One of the greatest technical challenges for Gravity Probe B is to keep its science instrument constantly supercooled. For the relativity experiment to operate properly, the science instrument must be kept just above absolute zero, at 1.8 Kelvin (-271.4° Celsius or -456.5° Fahrenheit) constantly for at least a year.



The science instrument is kept at this supercold temperature, by placing it in a special 2,441 litre (645-gallon) Dewar, or Thermos, about the size of the mixing tank

on a cement truck, that is filled with liquid helium in a superfluid state. This nine-foot tall Dewar is the main structure of the GP-B satellite itself. In its 640-kilometer (400-mile) high polar orbit, the GP-B satellite is low enough to be subjected to heat radiating from the Earth's surface, and it is also subjected to alternating hot and cold cycles, as it passes from intense sunlight into the Earth's shadow every ninety-seven minutes. Throughout the life of the mission, key portions of the science instrument must be maintained at a constant temperature to within five millionths of a degree centigrade.

The Dewar's inner chamber is a vacuum, which limits the amount of heat penetrating through the outside wall into the inner chamber containing the science instrument. In addition, it includes several other devices for maintaining the necessary supercold temperature:

- Multilayer insulation—multiple reflective surfaces in the vacuum space to cut down radiation
- Vapor-cooled shields—metal barriers, suitably spaced, cooled by the escaping helium gas
- Porous Plug—invented at Stanford, and engineered for space at NASA Marshall Space Flight Center in Huntsville, AL and the Jet Propulsion Laboratory in Pasadena, CA, this plug allows helium gas to evaporate from the Dewar's inner chamber, while retaining the superfluid liquid helium inside.

Virtually no heat can penetrate from the outside wall of the Dewar through the vacuum and multilayer insulation inside. However, a small amount of heat (about as much as is generated by the message indicator lamp on a cell phone) leaks into the Dewar from two sources:

- 1) Conduction of heat flowing from the top of the Dewar into the liquid helium
- 2) Radiation leaking down through the telescope bore into the liquid helium.

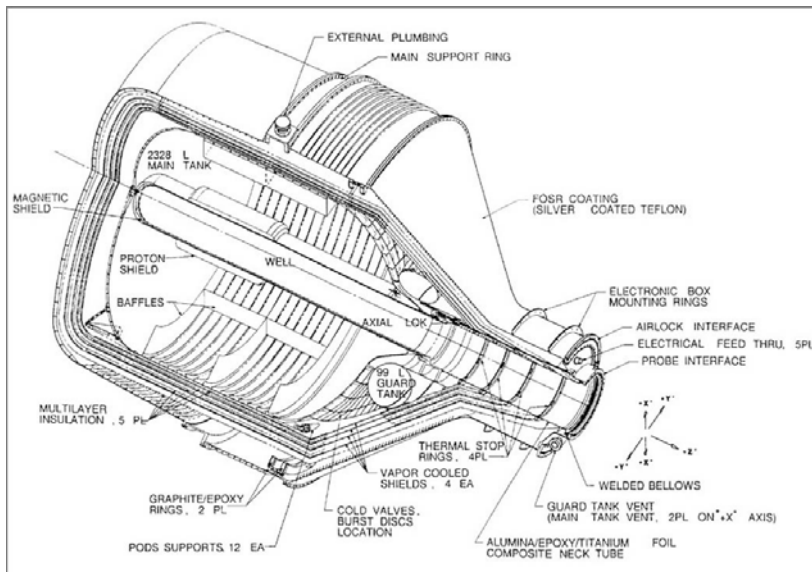

The porous plug controls the flow of this evaporating helium gas, allowing it to escape from the Dewar, but retaining the superfluid helium. The plug is made of a ground up material resembling pumice. The evaporating helium gas climbs the sides of the inner tank near the plug and collects on its surface, where it evaporates through the

pores in the plug, much like sweating in the human body.

The evaporating helium provides its own kind of refrigeration. As the helium gas evaporates at the surface of the porous plug, it draws heat out of the liquid helium remaining in the Dewar, thereby balancing the heat flow into the Dewar. You can feel this effect on your skin when you swab your skin with water. As the liquid evaporates off your skin, it draws heat energy with it, leaving your skin a tiny bit cooler than before.

The helium gas that escapes through the porous plug is cycled past the shields in the outer layers of the Dewar, cooling them (thus the name, “vapor-cooled shields”), and then it is vented out into space through eight pairs of thrusters that are strategically located around the spacecraft.

Based on data from the on-board telescope and the gyroscope that is used as a proof mass, the flow of the escaping helium gas is carefully metered through these thrusters in order to precisely control the spacecraft’s position. In fact, the position of the entire spacecraft is balanced around the proof mass gyroscope by increasing or decreasing the flow of helium through opposing thrusters, creating a drag-free orbit. Thus, the Dewar and liquid helium serve two critically important functions in the mission:

- 1) Maintaining a supercold temperature around the science instrument.
- 2) Providing a constant stream of gas propellant for precisely controlling the position and attitude of the entire satellite.

Drag-Free Satellite

As the GP-B satellite orbits the Earth with its four gyroscopes inside, one may assume that the satellite carries the gyroscopes around the Earth in polar orbit. After all, the gyroscopes spin inside four quartz housings that are rigidly attached inside the spacecraft. Whatever orbit the spacecraft follows, the gyroscopes will be forced to follow as well.

In fact, one of the gyroscopes inside the satellite is following an orbit of its own—a near-perfect gravitational free-fall orbit around the Earth. This gyroscope acts as a “proof mass,” showing GP-B the path of a near-perfect orbit. This gyroscope spins inside its housing a mere millimeter from the edge. The satellite uses sensors inside the housing to keep the spacecraft perfectly oriented around the spinning gyroscope and, therefore, follows the “proof mass” around the Earth in a near-perfect orbit.

For the most part, the satellite stays on course by following the same free-falling orbit. However, outside the satellite, two factors can alter the satellite’s path. The solar radiation streaming from the Sun is enough to knock the satellite askew, and friction from atmospheric gases can slow the satellite down.

GP-B needs extremely sensitive thrusters to re-orient the satellite and keep it on its proper path. Here’s where the escaping helium gas that slowly boils off from the liquid helium comes in handy. Minute amounts of gas, 1/10th of a human breath or a few millinewtons of force, provide just the right amount of thrust necessary to adjust the satellite’s position. The thrust force of the escaping helium gas provides plenty of force to keep the GP-B satellite in its precise position (within 10 milliarcseconds of a perfect Earth orbit, pointing to within 1 milliarcsecond of the exact center of the guide star).

The first drag-free satellite was the U.S. Navy’s Triad transit navigation satellite launched in 1972. Transit satellites enable ships to locate their positions on the Earth’s surface by reference to orbit data stored on board the satellite, but earlier ones had been limited by uncertainties in orbit prediction arising from atmospheric drag. Triad overcame this uncertainty by incorporating a drag-free controller, the

Why Low Earth Orbit?

Why does the GP-B satellite orbit so close to the Earth’s atmosphere? Even at the edge of the Earth’s atmosphere, the individual molecules and atoms of the atmosphere create too much friction for the satellite to follow its precise orbit. Why not orbit farther from Earth, outside its atmosphere?

The reason is that the effects of local spacetime (its curve and twist) weaken dramatically as one moves farther from the Earth. GP-B chose an orbit that would get it as close to the Earth as possible, in order to maximize the effects of local spacetime. A 400-mile altitude was the closest GP-B could get with a tolerable amount of atmospheric friction.

DISturbance COmpensation System (DISCOS), developed by Stanford Aero-Astro Department as an offshoot of Gravity Probe B research. Drag-free technology is now standard on transit satellites.

The Telescope & the Guide Star

In the GP-B science instrument, enclosed within the Probe, along the central axis of the Dewar, a 36 centimeter (14 inch) long Cassegrain reflecting astronomical telescope, with a focal length of 3.8 meters (12.5 feet), is optically bonded to the end of the quartz block that houses the gyroscopes. Together, the telescope and the quartz block form the Science Instrument Assembly (SIA). Optical bonding is a patented method of fusing together quartz parts, without the use of any “glue” or fasteners. This is necessary for the SIA not to distort or break when cooled to the cryogenic temperatures required for superconductivity used by the gyroscopes. The telescope’s line of sight provides a frame of reference for measuring any drift in the gyroscopes’ spin axis over the life of the experiment.

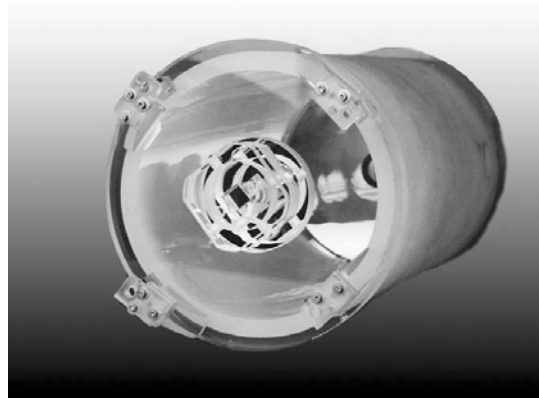

The telescope must be focused on a distant stable reference point—a guide star—and it must remain fixed on the center of this guide star within a certain range (± 20 milliarcseconds) throughout the mission. The resulting telescope signal is continuously subtracted from the gyroscope signal at the 0.1 milliarcsecond level to determine the amount of spin axis drift in each gyroscope.

Ideally, the telescope would be aligned with a distant quasar (massive bodies, located in the most distant reaches of the universe, which put out powerful radio emissions), because they appear to be fixed in their position and would thus provide an ideal, stable reference point for measuring gyroscope drift.

However, quasars are too dim for any optical telescope this size to track. So, instead, the telescope must be focused on a brighter, nearby star. But, like the Sun, nearby stars move relative to the other stars in our galaxy, and their light diffracts or scatters as it travels through the universe. This situation posed two difficult challenges to the experiment:

- 1) Choosing a guide star whose motion can be mapped relative to quasars separately, so that the Gravity Probe B gyroscope measurements can be related to the distant universe.
- 2) Creating a means for the telescope to find and remain focused on the exact center of a star whose light is widely diffracted.

Choosing and Mapping a Guide Star with VLBI

In order to precisely map the motion of a star relative to a quasar, it was necessary to find a star that meets all of the following criteria:

- Correct position in the heavens for tracking by the on-board telescope (for example, the sun never gets in the way)
- Shines brightly enough for the on-board telescope to track
- Is a sufficiently strong radio source that can be tracked by radio telescopes on Earth
- Is visually located within a fraction of a degree from the reference quasar

It so happens that stars that are radio sources belong to binary star systems. Because almost half the star systems in the universe are binary, it initially seemed that there would be many good candidates for the guide star. However, out of 1,400 stars that were examined, only three matched all four of the necessary criteria. The star that was chosen as the GP-B guide star is named IM Pegasi (HR 8703).

IM Pegasi moves around its binary partner in a spiraling pattern, rather than a linear path. The total motion of IM Pegasi in one year alone is 100 times larger than the smallest gyroscope spin axis drift measurable with Gravity Probe B. Clearly this motion has to be determined with high accuracy for Gravity Probe B to be successful.

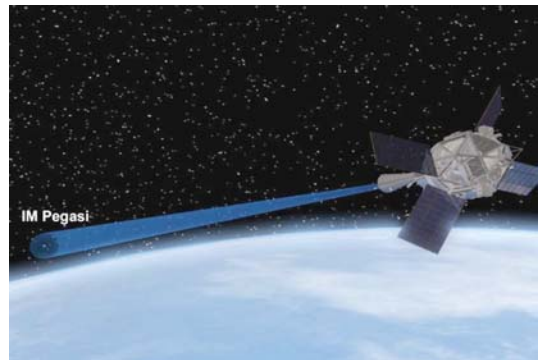

IM Pegasi -- HR8703

IM Pegasi means “of or in Pegasus”, which is a constellation easily seen high overhead on autumn evenings throughout North America, Europe, and Asia. The guide star is actually part of a binary star system, like 46% of the stars in our universe. The binary star system consists of two stars closely orbiting each other.

In the case of IM Pegasi, a smaller star orbits the larger star that GP-B focuses on. The smaller star does create some wobble in the larger star, as it draws the larger star from side to side while it orbits. This is another motion that GP-B must account for when focusing on the exact center of the larger star.

IM Pegasi Facts

Distance: ~300 light years

Right Ascension: 22.50'34.4" Magnitude max. - 5.85

Declination: 16.34'32" Magnitude min. - 5.6

Because IM Pegasi is also a radio source, its motion can be tracked by a sophisticated system of radio telescopes, operating in conjunction with each other. This system is called the Very Long Base Interferometry or VLBI. Radio telescopes from New Mexico to Australia to Germany, acting as a single radio telescope the size of the Earth, focus on IM Pegasi and map its movements. The results are images of IM Pegasi and extremely accurate measurements of its motions with respect to a reference quasar. With these measurements the motions of the gyroscope spin axes can be related to the distant universe.

Splitting the Guide Star Image

Diffraction, the light-scattering phenomenon that produces rings around the moon, spreads IM Pegasi's image to a diameter of 1,400 milliarcseconds, corresponding to a focused image 0.001 inch across. Locating the star's center to 0.1 milliarcsecond means finding the image's optical center to one ten-millionth of an inch—a formidable task.

GP-B accomplishes this task by focusing the starlight in the "lightbox" at the telescope's front end, and passing it through a beam-splitter (a half-silvered mirror). The beam-splitter forms two separate images, each of which falls on a roof-prism (a prism shaped like a peaked rooftop). The prism slices the star's image into two half-disks, which are directed to hit opposite ends of a tiny sensor.

On the sensor, the light signals of each half-disk are converted to electrical signals and then compared. If the signals are not precisely equal, this means that the roof-prism is not splitting the image precisely in half. The entire space vehicle is then adjusted until the signals are equal and the image is split right down the middle. When this is accomplished in both sensors for each axis (x- and y-axes), then the telescope is focused on the exact center of the guide star.

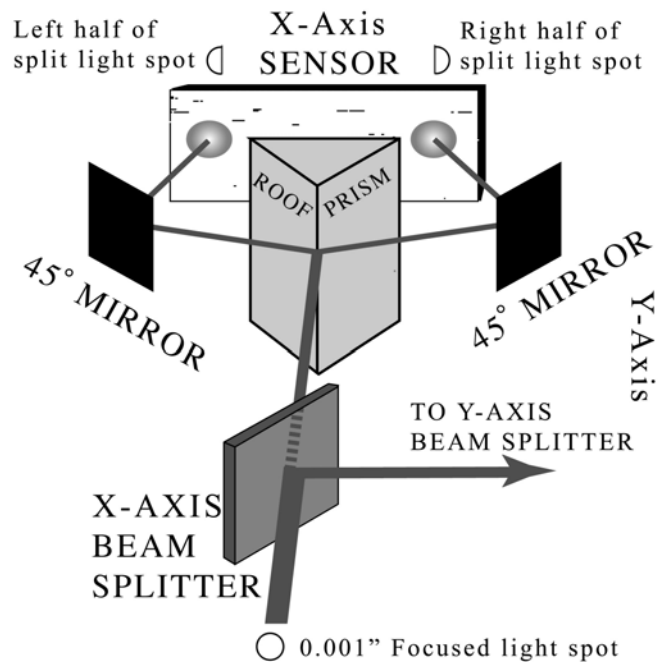

Seven Near Zeroes

Designing an experiment involves a basic choice: maximize the effect to be measured, or minimize the “noise” that obscures it. For the Gravity Probe-B experiments, however, that choice was moot because Einstein’s relativistic effects, that literally “roar” near black holes and neutron stars, barely whisper here on earth. The Gravity Probe-B has to turn the volume of the extraneous babble down to zero in order to hear the whisper. It’s like asking everyone in a football stadium to sit quietly to hear a bird sing.

The noise affecting near-earth relativistic effects comes from virtually anything that might distort the results. From the slightest amount of heat or pressure, the influence of any magnetic field, any kind of gravitational acceleration, or the tiniest amount of atmospheric turbulence or solar radiation, to the smallest imperfections in the instruments themselves, the tolerances must be at or near zero.

Without seeing them up close it’s hard to image the precision of the instruments. Gravity Probe B’s four gyroscopes, housings, and telescopes are all carved out of a single purified quartz block, grown in Brazil, refined in Germany, and delivered to GP-B as a trash-can-size crystal. From side to side, the crystalline structure of the quartz is identical and homogenous to within three parts per million. The gyroscope spheres are less than 40 atomic layers from a perfect sphere, the most perfectly round objects ever made by man, so they can spin for over a year without any significant drift. To put that in perspective, if the gyroscopes were enlarged to the size of the Earth, the highest mountain or the deepest ocean trench would be only 8 feet. The electrical charge at the gyroscopes’ surface, known as the electric dipole moment, are likewise vanishing small, held to less than five parts in ten million.

The isolation of the instruments from their surroundings is equally impressive. The entire set of instruments is in a near-perfect vacuum, surrounded by 645 gallons of liquid helium cooled to a temperature of 1.8K. The helium’s temperature is held constant, just above absolute zero, by insulating the Thermos jug-like Dewar and releasing any evaporating helium through the one-of-a-kind porous plug.

To zero out unwanted magnetic fields, the instruments were built within a cascading succession of four lead bags within bags. After each new bag was inserted, the outside bag was removed, to virtually eliminate any residual magnetic fields. Additionally, while in orbit, the on-board electronics will monitor the position of the spinning gyroscopes by sensing the weak magnetic field produced by each one, and make the necessary corrections. The net result is the absence of any magnetic fields, even from the earth itself, that might affect the results.

Finally, and perhaps most impressive of all, is that the GP-B space vehicle will orbit the Earth in a near-perfect circle, almost completely free from any acceleration due to gravity. Eight opposing pairs of proportional micro thrusters enable the space

vehicle to automatically control its attitude or orientation with extreme precision. In addition, the satellite spins continuously to average out various disturbing effects. Floating serenely in orbit, the satellite experiences less than one ten-billionth of the gravity felt on the Earth's surface, and the gyroscopes spin suspended in space touching nothing solid for their entire lifetimes.

Gravity Probe B promises to be the near-perfect instrument placed in a near-zero environment.

GP-B Seven Near Zeroes	
<i>Temperature:</i>	<i>1.8 Kelvin (-271.4° Celsius or -456.5 Fahrenheit)</i>
<i>Gravitational Acceleration</i>	<i>Less than 10^{-10} g</i>
<i>Magnetic Field</i>	<i>Less than 10^{-6} gauss</i>
<i>Pressure</i>	<i>Less than 10^{-11} torr</i>
<i>Material Homogeneity</i>	<i>Less than 3 parts per million</i>
<i>Mechanical Sphericity</i>	<i>Less than 3 ten millionths of an inch</i>
<i>Electrical Sphericity</i>	<i>Less than 5 parts per ten million</i>

Unique Inventions & Innovations

When the GP-B experiment was conceived in 1960, much of the technology had not yet been invented to accomplish this exacting test. Here are the highlights of eight of GP-B's inventions and clever solutions to difficult challenges.

Porous Plug

Challenge: On Earth, Dewars (Thermos bottles) function because of gravity. The liquid and gas naturally separate. In the zero gravity of space, a different method of separation is needed.

Solution: Release the evaporating helium while retaining the superfluid liquid helium. The porous plug in the Dewar allows this.

Result: Retaining superfluid helium in the Dewar maintains the science instrument's temperature (1.8K or -271.35 °C) and extends the life of the mission.

Nested Expanding Lead Bags

Challenge: Earth's magnetic field interferes with the hyper-sensitive magnetometer (SQUID), which reads each gyroscope's orientation to within 0.5 milliarcseconds.

Solution: Block out the ambient magnetic field by surrounding the science instrument with a "lead bag." Four lead bags are actually used. The first one is inserted and expanded, partially reducing the magnetic field. Another bag is then inserted inside the first one and expanded, further reducing the magnetic field inside the second bag. The outer bag is then cut away. This process is repeated two more times, all but eliminating the magnetic field within the innermost bag. At this point the probe, containing the gyroscopes and SQUIDS is inserted inside the final remaining lead bag.

Result: The series of four nested and expanded lead bags reduces the magnetic level to less than 10^{-6} gauss. Then, magnetic shields surrounding each individual gyroscope and other local magnetic shields attenuate the magnetic variation down to 10^{-14} gauss.

Proportional Micro Thrusters

Challenge: GP-B satellite's path is altered, ever so slightly, by solar radiation and atmospheric "wavetops".

Solution: Re-orient the satellite with an extremely sensitive gas thruster system. Helium gas constantly flows out of eight pairs of opposing thrusters in balanced amounts. To alter the satellite's attitude, the gas flow in one or more pairs of opposing thrusters is unbalanced by $1/100^{\text{th}}$ of a "puff" exhalation that one might use to clean eyeglasses, providing just a few millinewtons of force.

Result: These proportional micro thrusters precisely maintain the GP-B space vehicle's position to within 10 milliarcseconds of a perfect Earth orbit, and pointing to within 1 milliarcsecond of the exact center of the guide star.

Bonus Fact: This is the ultimate in recycling...the helium gas that continually evaporates through the porous plug from the superfluid liquid helium inside the Dewar, is harnessed as the propellant used by the proportional micro thrusters.

Polishing the Perfect Sphere

Challenge: Polishing a fused quartz sphere with standard methods creates "hills and valleys," destroying sphericity.

Solution: Create a tetrahedral lapping and polishing machine that brushes the sphere with micro-inch abrasive slurry in random variations.

Result: Each fused quartz sphere deviates less than one micro-inch from peak to valley (25 nm), making them the roundest objects ever created on Earth.

Precisely Measuring Sphericity (Roundness)

Challenge: How to measure the roundness of a sphere at the precision level of $1/10^{\text{th}}$ of one millionth of an inch? The British instrument company, Rank, Taylor, and Hobson, created the Talyrond instrument for measuring the sphericity or roundness of GP-B gyroscope rotors using a stylus mounted on a round spindle to encircle a gyroscope rotor. However, they could not produce a spindle that was itself perfectly round, and thus the spindle introduced error into the measurement.

Solution: Combine the errors in the spindle's roundness with the errors in the sphere being measured. Then, rotate the sphere to a new position and repeat the measurement. The measurement errors in the roundness of the spindle remain constant, while the measurement errors in the sphere change with each new position. After repeating this process several times, it is possible to separate out the

constant spindle error. (The spindle roundness must be checked from time to time, to ensure that it has not changed.)

Result: The spindle roundness errors were calculated and stored in a computer, so they could be reused with different spheres. For each rotor, 16 great-circle measurements were made in the perpendicular plane and one final measurement was made around its equator, tying all the vertical measurements together. The spindle errors were subtracted out of the sphericity measurements, and then the sphericity measurements were translated into contour maps.

Gyroscope Suspension System

Challenge: Suspend each spinning gyroscope in the exact center of its housing, a mere $1/400^{\text{th}}$ centimeter – $1/1000^{\text{th}}$ inch from the side of the housing.

Constraint 1: The suspension mechanism must be able to react instantly to misalignments, without overreacting and sending the gyroscope crashing into the side.

Constraint 2: The gyroscopes must maintain a spin rate of between 5,000 and 10,000 rpm.

Solution: Six electrodes placed evenly around the gyroscope create a charge that electrically suspends the gyroscope. The charge attracts the gyroscope's niobium surface. Using a few millivolts, the gyroscopes are constantly balanced in the center of the housing with every electrode reacting dynamically to any adjustments by the other electrodes.

Bonus Fact: While in space it will take less than 100 millivolts to suspend the gyroscopes, whereas on Earth it takes nearly 1,000 volts to raise and balance the gyroscopes against the force of gravity.

Gas Management Assembly

Challenge: Spin up an ultra-smooth gyroscope as fast as possible without crashing it into the sides of the housing with an electrical spark.

Constraint 1: As gas flows into housing chamber, it can only exit as fast as the exhaust tube will allow.

Constraint 2: The exhaust tube must be very small ($< 1/16^{\text{th}}$ of an inch) to prevent outside heat from reaching the housing chamber and the gyroscope.

Constraint 3: If more gas flows into the chamber than flows out, the pressure inside the chamber will rise. As the pressure rises, the helium will ionize and possibly arc. The electrical spark could knock the electrically suspended gyroscope out of position and into the side of the housing.

Solution: A gas management system was designed specifically for spinning up the GP-B gyroscopes. It uses more than two dozen valves and numerous levels of redundancy to send ultra-pure helium gas into the chamber at 725 sccm (standard cubic centimeters per minute).

Result: The gyroscopes spin up to full speed of between 5,000-10,000 rpm in less than three hours.

The IDA and DPA Inside the Telescope

(Image Divider Assembly & Detector Package Assembly)

Challenge: GP-B's telescope must locate the center of guide star to within $1/10^{\text{th}}$ of a milliarcsecond. No existing telescope is accurate enough to accomplish this task.

Solution: Split the incoming light with a roof-prism (inside the IDA) and direct each half toward two sensors (inside the DPA). When each sensor registers an identical amount of electrical flux, the telescope is centered.

Result: Each sensor can detect the amount of light hitting it to within a few photons. The telescope can be adjusted to remain focused on the exact center of guide star, thereby precisely maintaining its original orientation.

Spinoffs from GP-B

Over its 40+ year lifespan, spinoffs from the Gravity Probe B program have yielded many technological, commercial, and social benefits. Following are a few examples.

Technology Spinoffs for Aerospace

Some of the technologies developed for Gravity Probe B have been used in other NASA and aerospace programs. One example is the porous plug at the top of the GP-B Dewar.

Dewar Porous Plug

One of the most critical devices for stabilizing the GP-B temperature is a “porous plug,” invented at Stanford and engineered for space at NASA Marshall Space Flight Center and the Jet Propulsion Laboratory. This plug has the unique ability to allow helium gas to escape while containing the liquid helium. It evaporates helium gas from the Dewar through pores, much like the human body sweats in a desert climate.

The porous plug, which was invented by a GP-B student, has since been used in NASA's IRAS and COBE missions.

Technology Spinoffs for Commercial Use

Spinoffs from Gravity Probe B aren't limited to aerospace applications. Some of them have found commercial applications, as well.

Guiding Tractors & Landing Aircraft

What does Gravity Probe B have to do with the military's Global Positioning System and an automated tractor? GP-B uses the GPS system to accurately locate the operations of its satellite in both space and time. However, normal civilian GPS receivers have a precision of only about 100 yards. GP-B enlisted the help of a system called “differential GPS”, which increases the accuracy to within one meter. Enterprising GP-B graduate students further improved the system to centimeter-level precision and applied it to develop automated tractors and automated aircraft landing. That's a big deal. For more information, read the Stanford Report article: ‘ Tractor drivers soon may say, “Look, Ma... No hands!” ’. (Video report also available from GP-B.)

Optical Bonding

How do you bond the quartz optical and mechanical components of a science instrument so as not to interfere with its workings?

You'd need a bonding technology with the following characteristics:

- Transparent to visible and near-infrared light
- Works in the vacuum of space
- Does not create any magnetic disturbance
- Is capable of handling rapid temperature changes and extreme cold (going from room temperature to $-271\text{ }^{\circ}\text{C}$ without even a hairline crack).

So much for Elmer's glue. Scientist Jason Gwo invented a new material called OptoBond™ to do the job. Industry applications include bonding improvements in optoelectronics, precision optics, laser optics, laser crystal augmentations, general optomechanical applications and creation of optical systems.

Photo-diode Detectors

Gravity Probe B engineers created a revolutionary detector mount system to provide thermal insulation between detector electronics, operating at 80 Kelvin, and a quartz telescope, operating at 2.5 Kelvin. The two dual photo-diode detectors also have to withstand 5.0 g forces and use less than one milliwatt of power per detector. The signals from these detectors must be clean enough to provide the star-tracking telescope of GP-B with an accuracy approaching 100 millionths of an arc-second per year. What's the practical application? Faster and more efficient digital cameras, among others. With technology allowing 5 g's of shock tolerance, you might be able to drop your camcorder a few times.

Spinoffs Benefiting Society

Less tangible, but perhaps most important, the Gravity Probe B program has had a profound effect on the lives and careers of numerous faculty and students—both graduate and undergraduate, and even high school students, at Stanford University and other educational institutions.

Student Involvement

The most important product of GP-B is trained minds. As of October, 2003, Gravity Probe B had produced 78 doctoral dissertations in seven departments at Stanford University and 16 at other universities, 15 Master's or Engineer's degrees, and not least important, rare and exciting opportunities for frontier research for about 300 undergraduates and 35 high school students.

GP-B alumni include the first woman astronaut, the CEO of a major aerospace company, professors at Harvard, Princeton, Stanford and elsewhere, a recent Nobel Laureate in Physics and many others in activities ranging from pure physics research related to making agriculture more efficient by GPS control of tractors to plow fields automatically without a farmer on board.

